

ZY-6258



**B20**

麦芒金  
玳瑁镜框



**B16**

麦芒金  
透灰镜框



**B21**

玫瑰金  
透茶棕镜框



**B29**

玫瑰金  
透茶棕渐进镜框

ZY-6259



# 产品参数

/

New Arrival

产品型号 6257

产品材质 TR

产品重量 约12g  
(仅镜框不含镜片)

产品功能 防蓝光/防辐射

产品尺寸

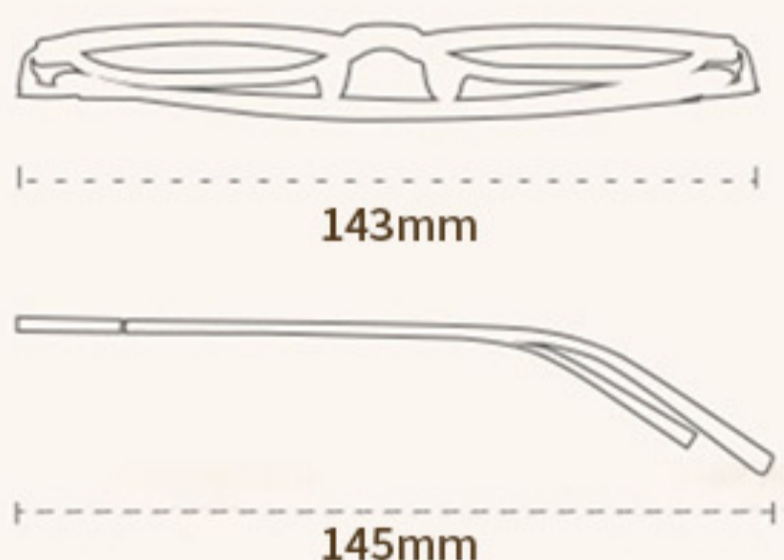

Tips:以上参数属于手工测量, 允许存在一定合理范围内误差, 具体以实物为准

## 满足你的多彩需求

04.

4种不同配色  
满足你的“高要求”

04



# PRODUCT 产品参数

产品型号 8911 镜架材质 合金+TR

镜片功能 护眼遮阳 眼镜重量 12G

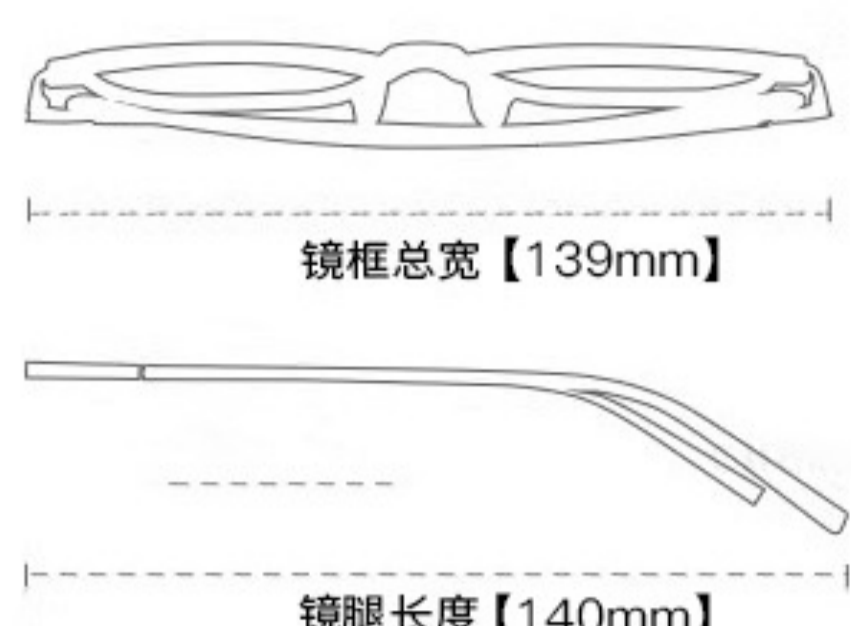

Tips:以上参数属于手工测量,允许存在一定合理范围内误差,具体以实物为准

适合脸型:



方圆脸



菱形脸



鹅蛋脸



瓜子脸

#黑银框黑灰片



#黑金框黑灰片



#透茶框茶片



#透灰框黑灰片



#黑金框



#黑银框



#灰绿框



#碎花框



#透灰框



#透明框



#透茶框



# PRODUCT PARAMETERS

## 产品参数

产品型号 63012 镜架材质 合金

镜片功能 高清遮阳 眼镜重量 20G

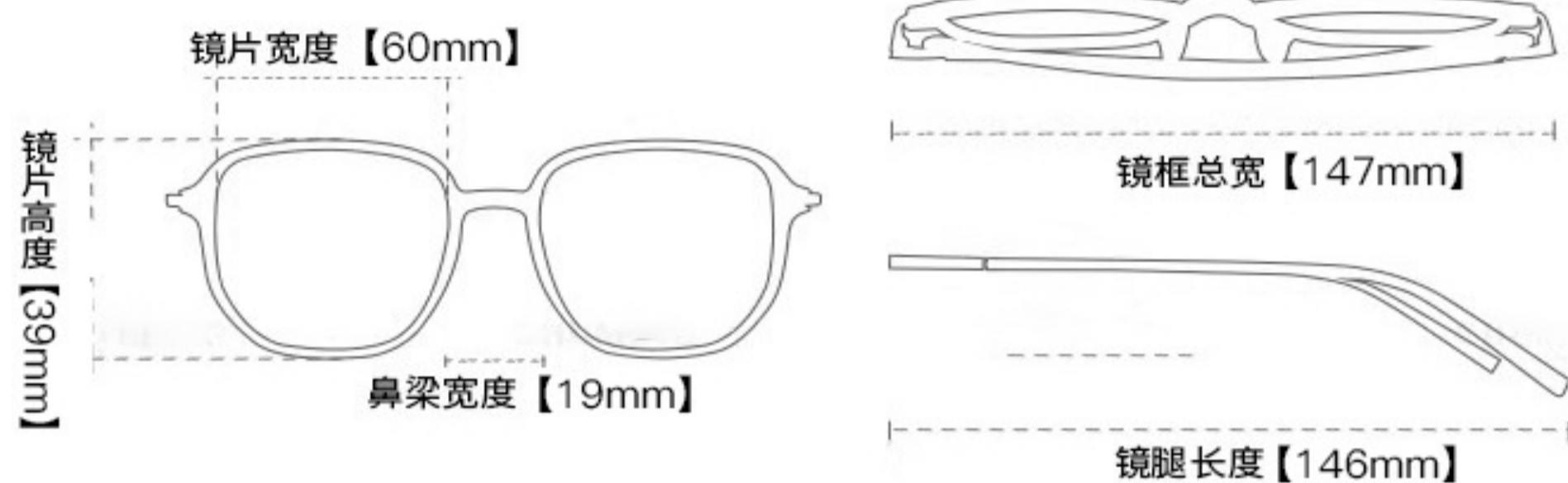

Tips:以上参数属于手工测量,允许存在一定合理范围内误差,具体以实物为准

适合脸型:



方圆脸



菱形脸



鹅蛋脸



瓜子脸



# 产品信息

PRODUCT INFORMATION

产品型号：6253

产品重量：10g

镜架材质：合金

镜片材质：防蓝光

产品功能：防蓝光

适用性别：男女同款

镜总宽

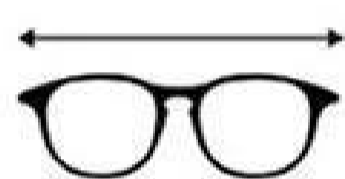

141mm

镜框宽

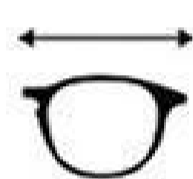

54mm

镜框高



35mm

鼻间距



19mm

镜腿长

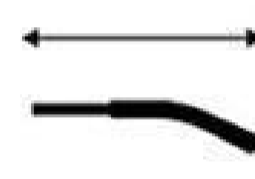

147mm

注：因测量方式不同存在1-3mm的误差，数据仅供参考，以实物为准

# 可选颜色

OPTIONAL COLOR



#玫金框



#亮金框



#灰枪框



#亮银框

# 产品参数

product  
parameters



产品型号: 6252

产品尺寸: 54□19-147

所属系列: 光学架

镜框材质: 金属

镜腿材质: 合金

镜片: 防蓝光

## COLOR DISPLAY



C1.亮银



C2.玫瑰金



C3.亮金



C4.亮中枪

# 产品信息

PRODUCT INFORMATION

产品型号：ZY-6226

产品重量：11g (仅镜框)

镜架材质：合金

镜片材质：树脂

产品功能：防蓝光

适用性别：男女同款

镜总宽



133mm

镜框宽



53mm

镜框高



34mm

鼻间距



17mm

镜腿长

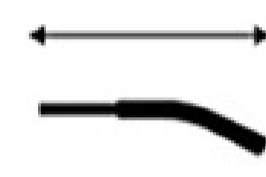

147mm

注：因测量方式不同存在1-3mm的误差，数据仅供参考，以实物为准

# 可选颜色

OPTIONAL COLOR

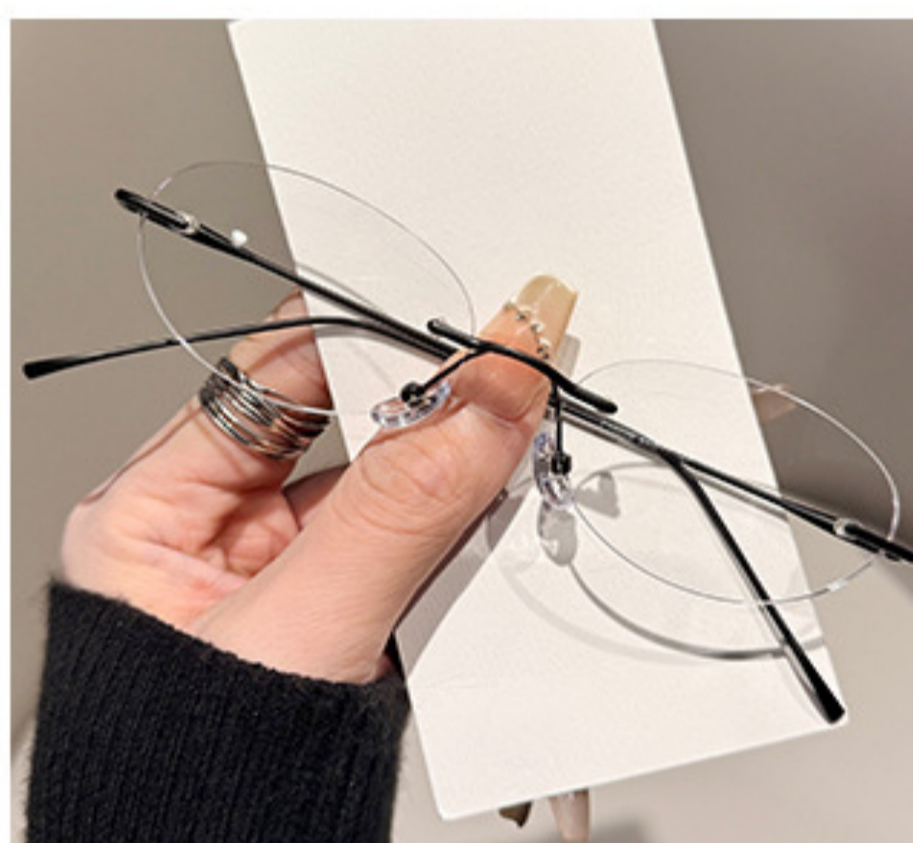

#砂黑色



#亮银色

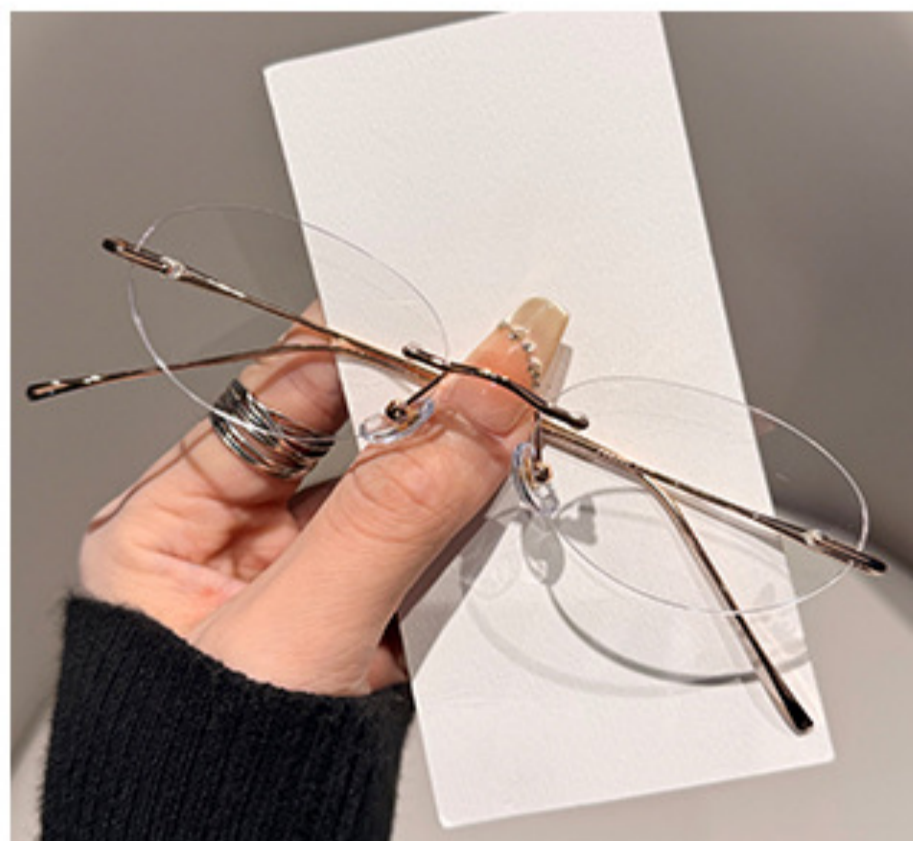

#玫金色



#亮金色

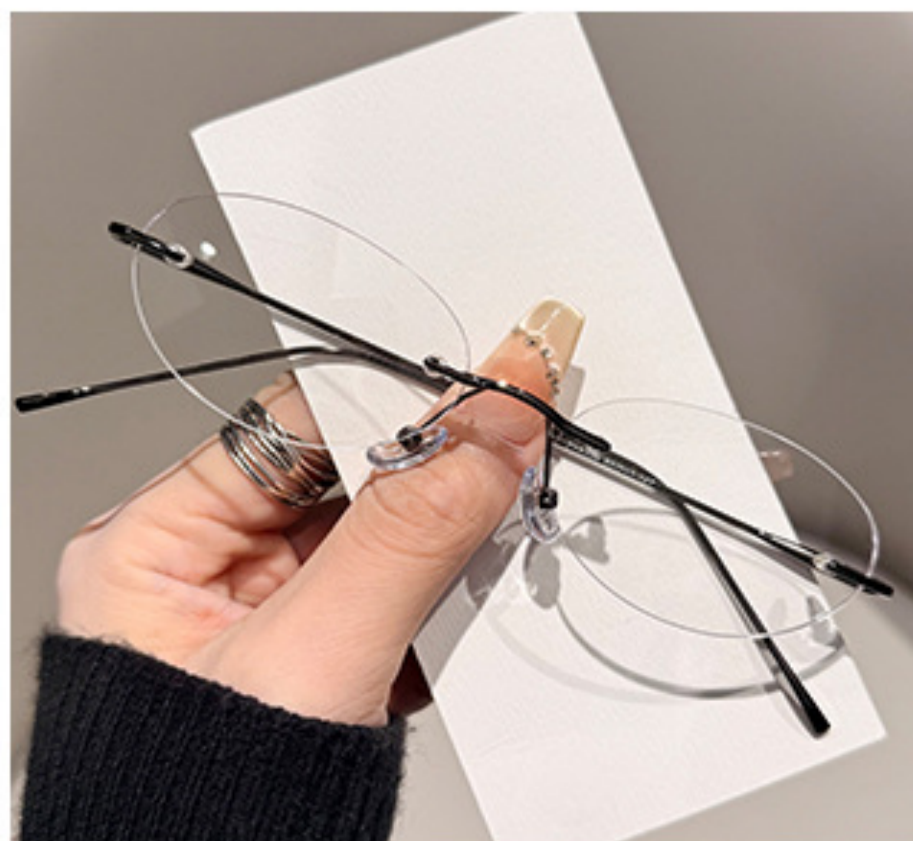

#亮枪色

# 产品信息

PRODUCT INFORMATION

产品型号：ZY-6223

产品重量：13g (仅镜框)

镜架材质：合金

镜片材质：树脂

产品功能：防蓝光

适用性别：男女同款

镜总宽



134mm

镜框宽



51mm

镜框高



46mm

鼻间距



20mm

镜腿长



147mm

注：因测量方式不同存在1-3mm的误差，数据仅供参考，以实物为准

# 可选颜色

OPTIONAL COLOR

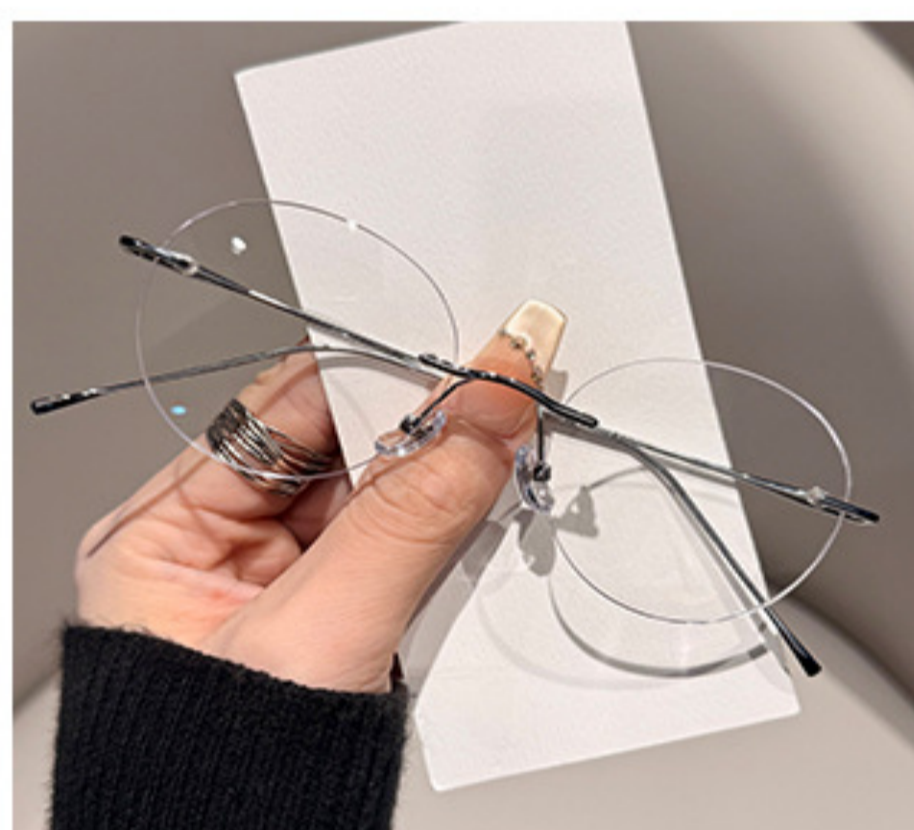

#亮银色



#亮金色

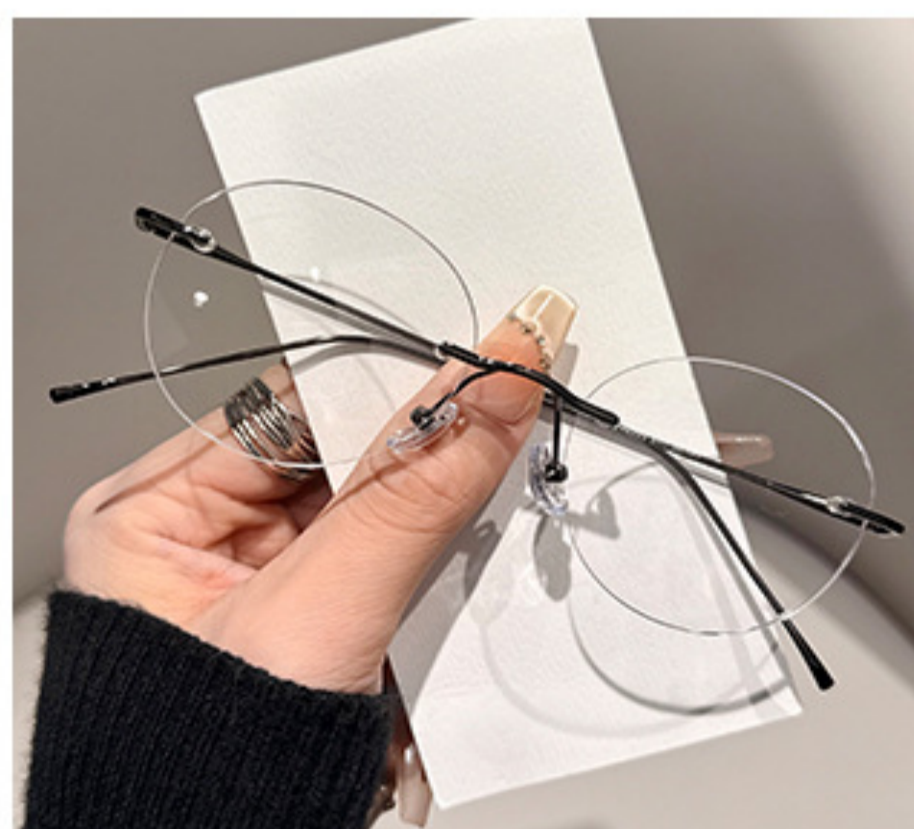

#亮枪色

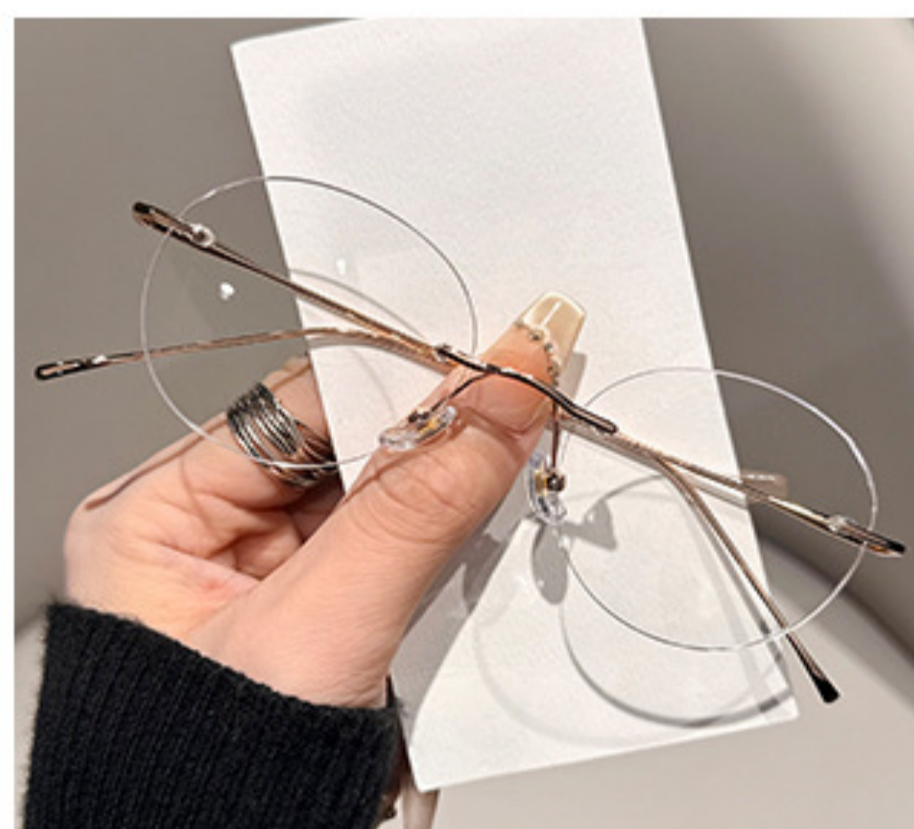

#玫瑰金

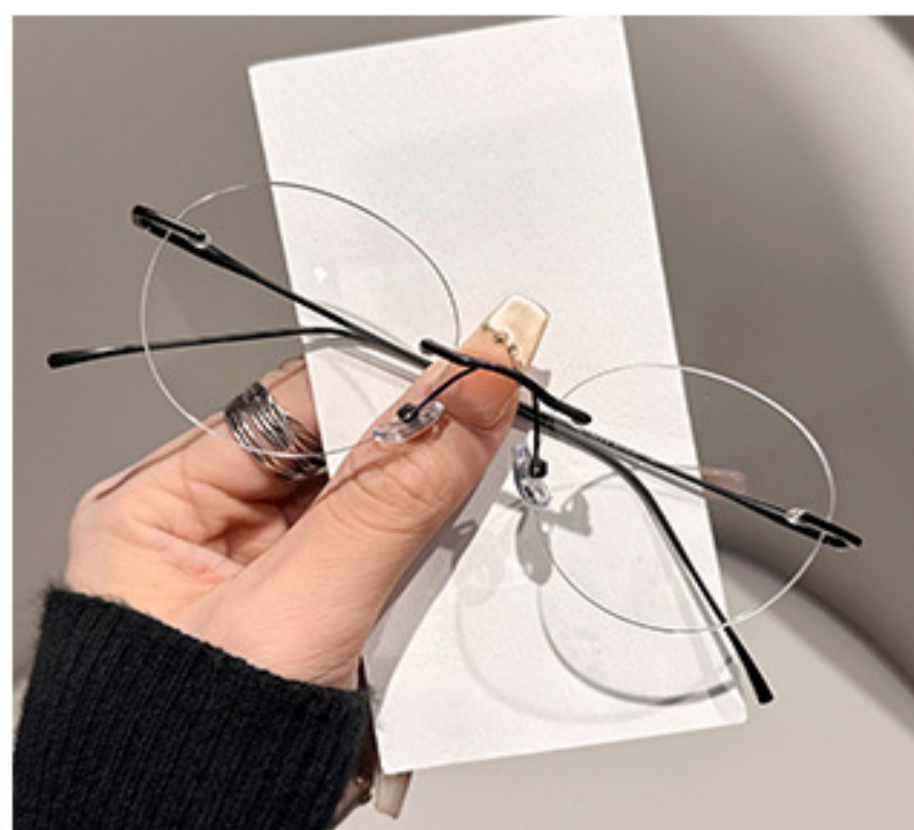

#砂黑色

# 产品信息

PRODUCT INFORMATION

产品型号：ZY-6227

产品重量：15g (仅镜框)

镜架材质：合金

镜片材质：树脂

产品功能：防蓝光

适用性别：男女同款

镜总宽



136mm

镜框宽

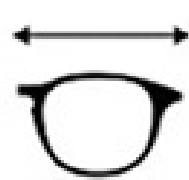

51mm

镜框高



47mm

鼻间距



20mm

镜腿长



145mm

注：因测量方式不同存在1-3mm的误差，数据仅供参考，以实物为准

# 可选颜色

OPTIONAL COLOR



#砂黑色



#亮金色

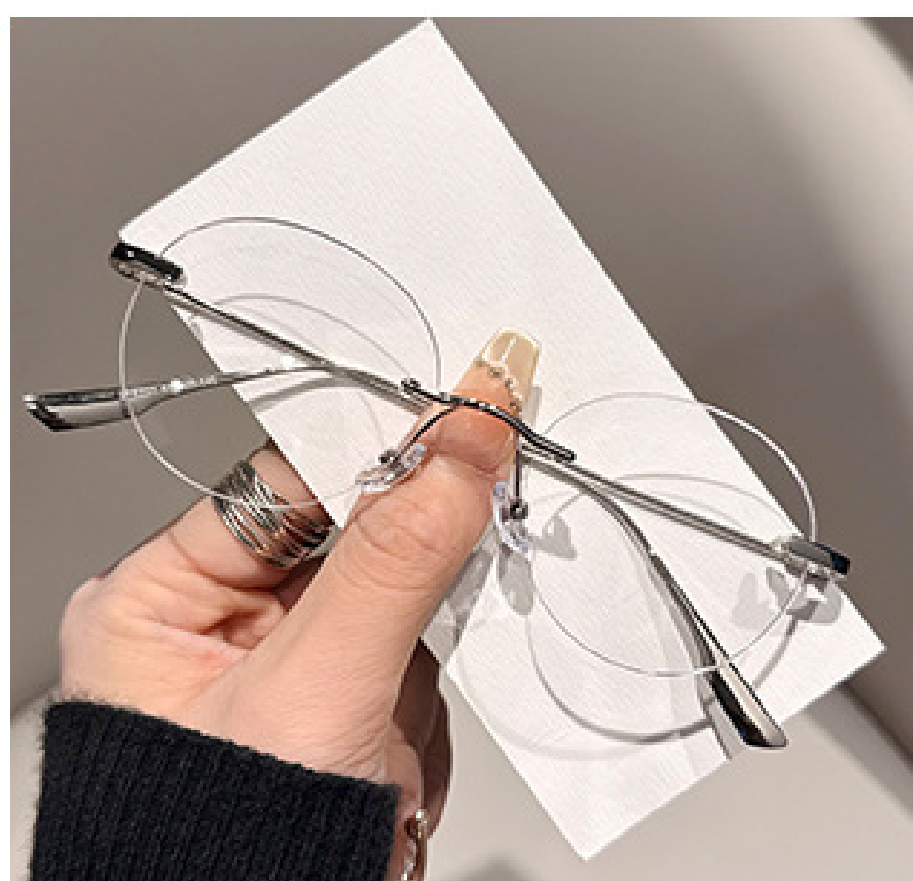

#亮银色



#玫金色

# 产品信息

PRODUCT INFORMATION

产品型号：ZY-6225

产品重量：13g (仅镜框)

镜架材质：合金

镜片材质：树脂

产品功能：防蓝光

适用性别：男女同款

镜总宽



135mm

镜框宽

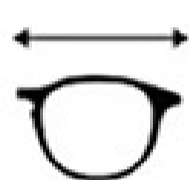

53mm

镜框高



34mm

鼻间距



17mm

镜腿长



145mm

注：因测量方式不同存在1-3mm的误差，数据仅供参考，以实物为准

# 可选颜色

OPTIONAL COLOR



#亮银色



#砂黑色



#玫金色

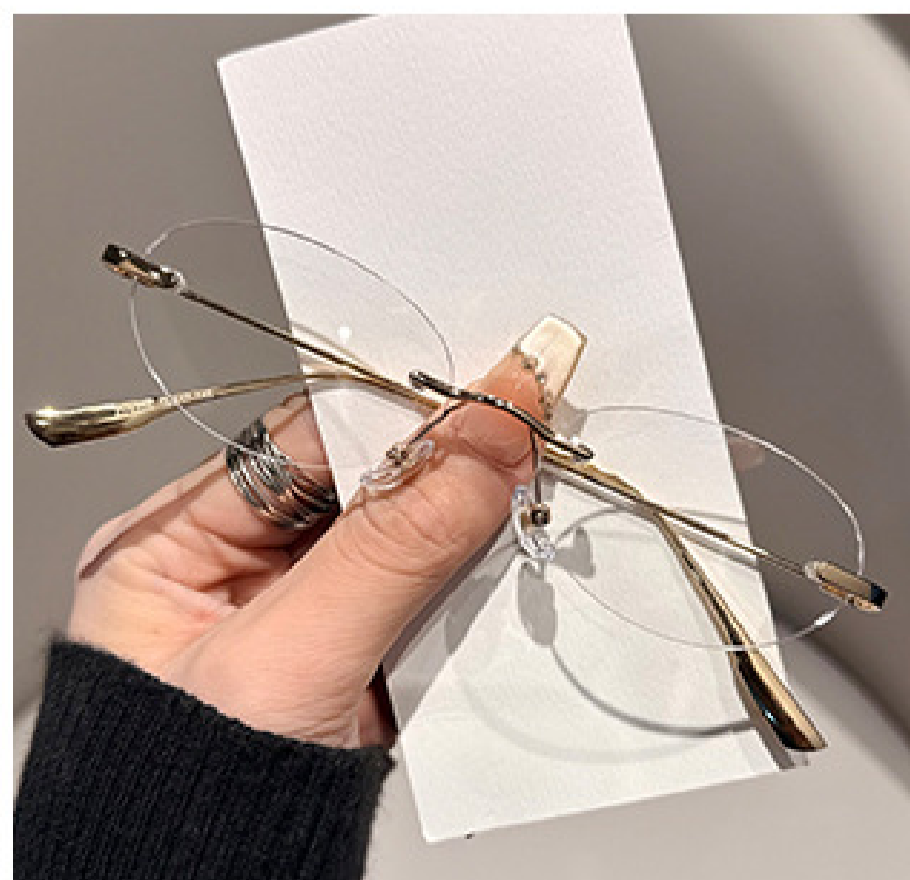

#亮金色

# 产品信息

PRODUCT INFORMATION

产品型号：ZY-90803

产品重量：13g (仅镜框)

镜架材质：合金

镜片材质：树脂

产品功能：防蓝光

适用性别：男女同款

镜总宽



136mm

镜框宽



54mm

镜框高



43mm

鼻间距



20mm

镜腿长



145mm

注：因测量方式不同存在1-3mm的误差，数据仅供参考，以实物为准

# 可选颜色

OPTIONAL COLOR

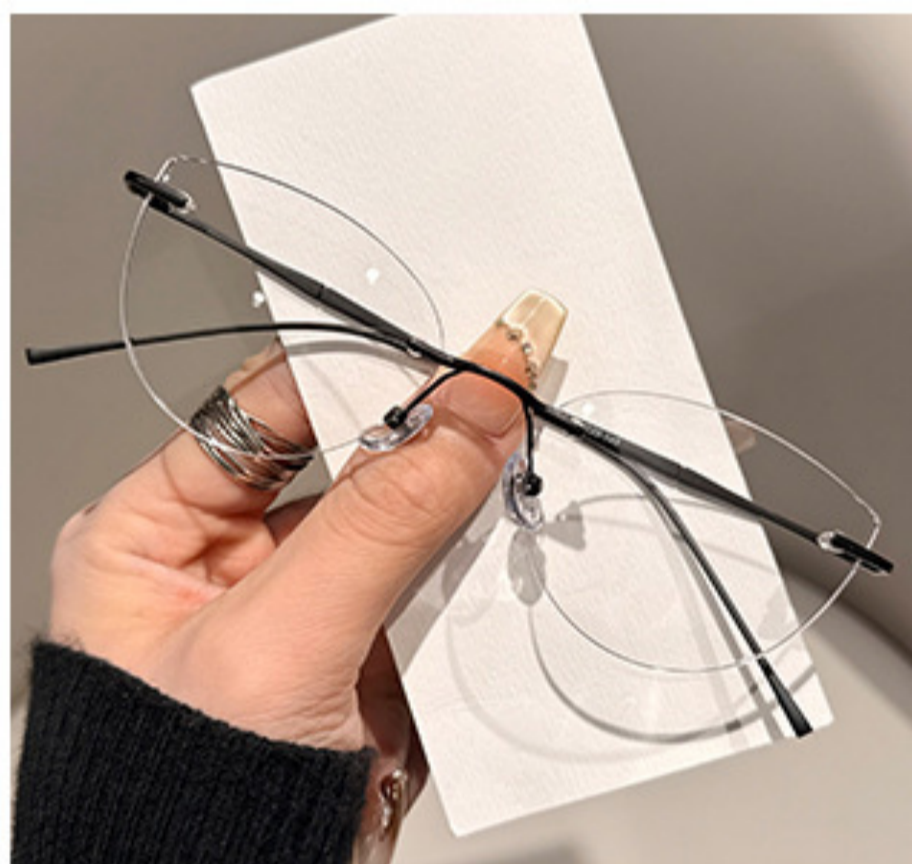

#砂黑色



#亮金色



#亮枪色

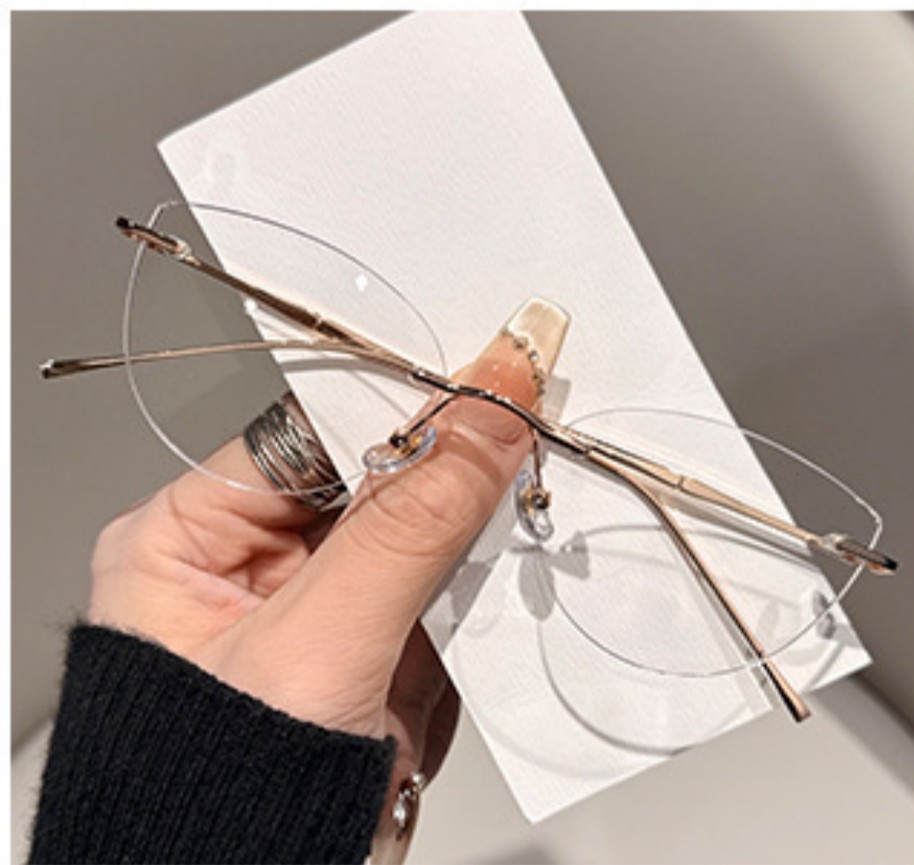

#玫金色



#亮银色

# 产品信息

PRODUCT INFORMATION

产品型号：90802

产品重量：18g

镜架材质：合金

镜片材质：树脂

产品功能：防蓝光

适用性别：男女同款

镜总宽



133mm

镜框宽



53mm

镜框高



43mm

鼻间距



18mm

镜腿长



140mm

注：因测量方式不同存在1-3mm的误差，数据仅供参考，以实物为准

# 可选颜色

OPTIONAL COLOR



#黑色框



#银色框



#玫金框

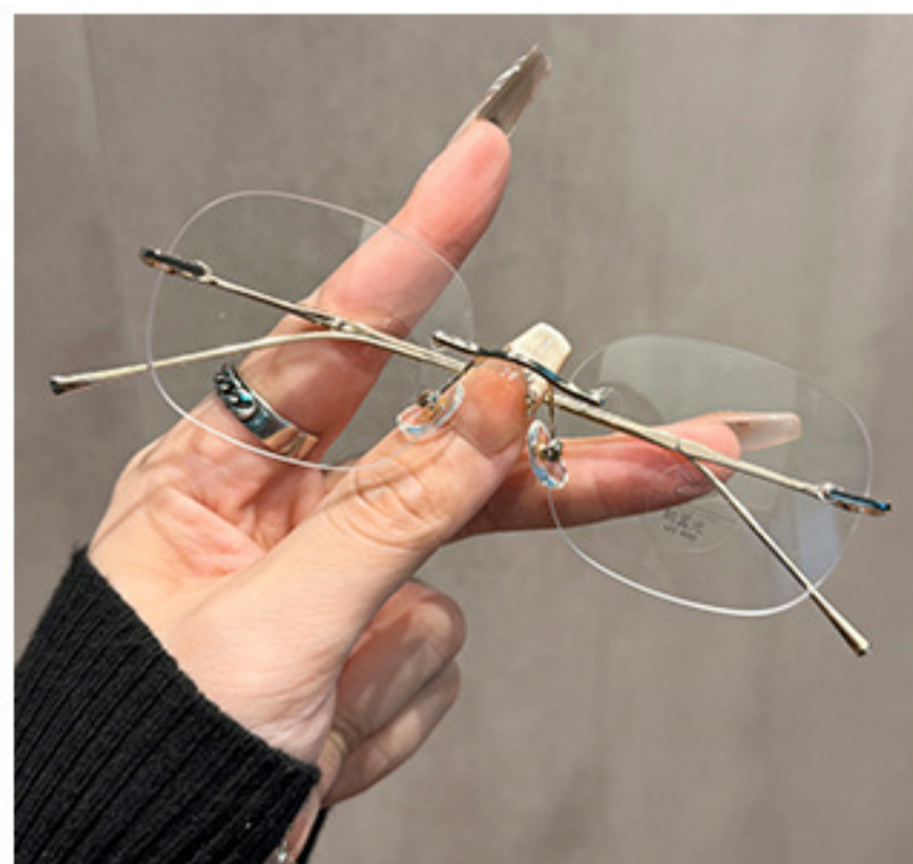

#金色框

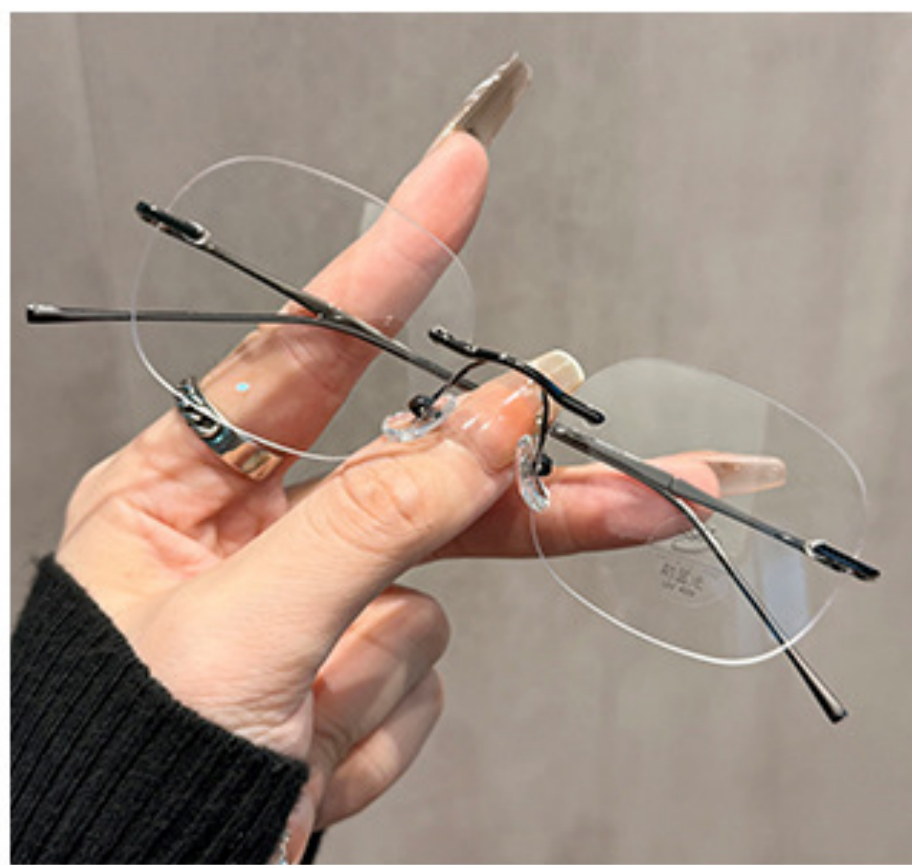

#枪色框

# INFORMATION

## 产品信息

类型：防蓝光眼镜

镜架材质：金属

型号：18095

颜色：5色可选

适合性别：中性

风格：简约



镜片高度  
43mm



鼻梁宽度  
18mm



镜框总宽  
137mm



镜片宽度  
53mm



镜腿长度  
145mm



镜框重量  
16g

注：因测量方式不同，可能存在微小误差，请以实物为准。

## 可选颜色



#亮黑色



#亮枪色



#亮金色



#亮银色



#玫瑰金

# Product Parameters

# 产品参数

产品型号: ZY-6222    产品功能: 防蓝光/装饰

眼镜重量: 22.3g(含镜片)    适合脸型: 通用脸型

镜框材质: 金属    适合性别: 男女款



镜总宽

138mm



镜片宽

53mm



镜片高

47mm



鼻间距

19mm



镜腿长

138mm

注: 以上尺寸均为手工测量, 存在一定的误差, 敬请谅解!

## COLOR DISPLAY

### 颜色展示



の 玫金框

ROSE GOLDEN



の 金框

GOLDEN



の 银框

SILVER



の 枪框

GUN



の 黑框

BLACK

# Product Parameters

# 产品参数

产品型号: ZY-6221

产品功能: 防蓝光/装饰

眼镜重量: 22.4g(含镜片) 适合脸型: 通用脸型

镜框材质: 金属

适合性别: 男女款



镜总宽

142mm

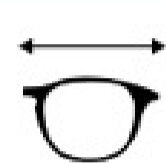

镜片宽

54mm



镜片高

50mm



鼻间距

19mm



镜腿长

136mm

注: 以上尺寸均为手工测量, 存在一定的误差, 敬请谅解!

## COLOR DISPLAY

### 颜色展示



の

玫金框

ROSE GOLDEN



の

金框

GOLDEN



の

银框

SILVER



の

枪框

GUN



の

黑框

BLACK

## Product Parameters

## 产品参数

产品型号: ZY-6220

产品功能: 防蓝光/装饰

眼镜重量: 18g(含镜片)

适合脸型: 通用脸型

镜框材质: 金属

适合性别: 男女款



镜总宽

138mm

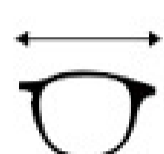

镜片宽

54mm



镜片高

41mm



鼻间距

17mm

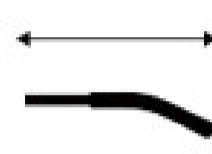

镜腿长

147mm

注: 以上尺寸均为手工测量, 存在一定的误差, 敬请谅解!

## COLOR DISPLAY

### 颜色展示



の

玫金框

ROSE GOLDEN



の

金框

GOLDEN



の

银框

SILVER



の

枪框

GUN



の

黑框

BLACK

# Product Parameters

# 产品参数

产品型号: ZY-23205 产品功能: 防蓝光/装饰

眼镜重量: 18.4g(含镜片) 适合脸型: 通用脸型

镜框材质: 金属

适合性别: 男女款



镜总宽

140mm

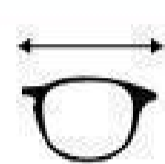

镜片宽

55mm

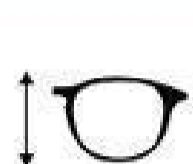

镜片高

41mm



鼻间距

17mm



镜腿长

145mm

注: 以上尺寸均为手工测量, 存在一定的误差, 敬请谅解!

## COLOR DISPLAY

### 颜色展示



の

金框

GOLDEN



の

黑框

BLACK



の

玫瑰金框

ROSE GOLDEN



の

枪框

GUN



の

银框

SILVER

# 产品信息

PRODUCT INFORMATION

产品型号：ZY18090

产品重量：18g

镜架材质：金属

镜片材质：树脂

产品功能：配镜/防蓝光

适用性别：男女同款

镜总宽



135mm

镜框宽



54mm

镜框高



42mm

鼻间距



18mm

镜腿长



149mm

注：因测量方式不同存在1-3mm的误差，数据仅供参考，以实物为准

# 可选颜色

OPTIONAL COLOR



#黑框



#玫瑰金框



#金框



#银框

# Product Parameters

# 产品参数

产品型号: ZY-18089 产品功能: 防蓝光/装饰

眼镜重量: 16.8g(含镜片) 适合脸型: 通用脸型

镜框材质: 金属

适合性别: 男女款



镜总宽

137mm

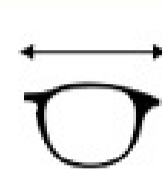

镜片宽

55mm



镜片高

33mm



鼻间距

17mm

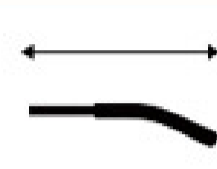

镜腿长

145mm

注: 以上尺寸均为手工测量, 存在一定的误差, 敬请谅解!

## COLOR DISPLAY

### 颜色展示



の

金框

GOLDEN



の

银框

SILVER



の

黑框

BLACK



の

枪框

GUN



の

玫金框

ROSE GOLDEN

# Product Parameters

# 产品参数

产品型号: ZY-19043 产品功能: 防蓝光/装饰

眼镜重量: 13.4g(不含镜片) 适合脸型: 通用脸型

镜框材质: 金属

适合性别: 女款



镜总宽

141mm

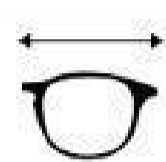

镜片宽

55mm



镜片高

40mm



鼻间距

19mm



镜腿长

145mm

注: 以上尺寸均为手工测量, 存在一定的误差, 敬请谅解!

## COLOR DISPLAY

### 颜色展示



亮黑框

BLACK



玫瑰金酒红

ROSE GOLDEN RED



银白

SILVER WHITE



奶茶金

MILK TEA GOLDEN



黑金

BLACK GOLDEN



金色

GOLDEN

# Product Parameters

# 产品参数

产品类型：防蓝光

产品型号：ZY-8836

产品功能：防蓝光/装饰

眼镜重量：17.8g

镜框材质：金属

适用性别：男女款



镜总宽

149mm



镜片宽

60mm



镜片高

40mm



鼻间距

18mm



镜腿长

142mm

注：以上尺寸均为手工测量，存在一定的误差，敬请谅解！



の

黑框防蓝光片

BLACK/ANTI BLUE LIGHT



の

金框防蓝光片

GOLDEN/ANTI BLUE LIGHT



の

银框防蓝光片

SILVER/ANTI BLUE LIGHT

# Product Parameters

# 产品参数

产品型号：ZY-8833

产品功能：防蓝光/装饰

眼镜重量：9.5g(不含镜片) 适合脸型：通用脸型

镜框材质：金属

适合性别：男女款



镜总宽

140mm

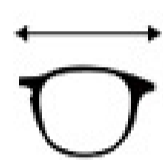

镜片宽

53mm



镜片高

38mm



鼻间距

18mm



镜腿长

142mm

注：以上尺寸均为手工测量，存在一定的误差，敬请谅解！

## AVAILABLE COLOR



金框茶腿



黑框黑腿



黑银框黑腿



红金框红腿



银框灰腿

PRODUCT  
PARAMETERS

# 产品参数

147mm

56mm

41mm

20mm

142mm

型号：ZY-8807

镜框材质：金属

镜片功能：防紫外线

镜框类型：椭圆形

适用性别：男女同款

产品重量：约24.1G

注：以上镜框尺寸数据均为手工测量，可能存在1~3mm误差，请以实物为准。

## COLOR

可选颜色



金框黑灰片



银框黑灰片



黑框浅茶片



金框茶片



金框墨绿片



黑框白片



金框白片



银框白片

# Product Parameters

# 产品参数

产品型号：ZY-11903

产品功能：配镜/装饰

眼镜重量：21.5g(含镜片) 适合脸型：通用脸型

镜框材质：金属

适合性别：男女款



镜总宽

143mm



镜片宽

56mm

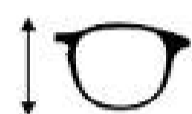

镜片高

31mm



鼻间距

16mm

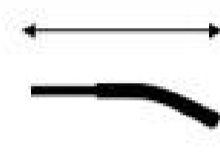

镜腿长

140mm

注：以上尺寸均为手工测量，存在一定的误差，敬请谅解！

## COLOR DISPLAY

### 颜色展示



の

银框  
SILVER



の

黑框  
BLACK



の

金框  
GOLD

# 产品信息

PRODUCT INFORMATION

产品型号: ZY-18088

产品重量: 17g

镜架材质: 金属

镜片材质: 树脂

产品功能: 防蓝光/配镜/装饰

适用性别: 男女同款

镜总宽



138mm

镜框宽



55mm

镜框高



32mm

鼻间距



17mm

镜腿长



147mm

注: 因测量方式不同存在1-3mm的误差, 数据仅供参考, 以实物为准

# 可选颜色

OPTIONAL COLOR



#枪色



#亮黑色



#亮金色



#玫瑰金

# Product Parameters

# 产品参数

产品型号: ZY-00236

产品功能: 防蓝光/装饰

眼镜重量: 13.6g(不含镜片) 适合脸型: 通用脸型

镜框材质: 金属

适合性别: 男女款



镜总宽

136mm



镜片宽

47mm



镜片高

37mm



鼻间距

18mm



镜腿长

142mm

注: 以上尺寸均为手工测量, 存在一定的误差, 敬请谅解!

## COLOR DISPLAY

### 颜色展示



の

亮黑框

BLACK



の

古铜框

BRONZE



の

银色框

SILVER



の

金色框

GOLDEN

# Product Parameters

# 产品参数

产品型号：ZY-18333 产品功能：防蓝光

眼镜重量：20g(含镜片) 适合脸型：通用脸型

镜框材质：金属 适合性别：男女款



镜总宽

135mm

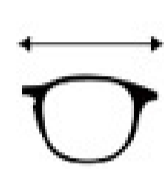

镜片宽

53mm

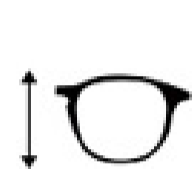

镜片高

49mm



鼻间距

16mm

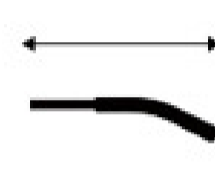

镜腿长

140mm

注：以上尺寸均为手工测量，存在一定的误差，敬请谅解！

## COLOR DISPLAY

### 颜色展示



の

玫瑰金框

ROSE GOLD



の

黑框

BLACK



の

黑银框

BLACK SILVER



の

黑金框

BLACK GOLD

## Product Parameters

## 产品参数

产品型号：ZY-93010 产品功能：防蓝光/配镜

眼镜重量：16.7g(含镜片) 适合脸型：通用脸型

镜框材质：金属 适合性别：男女款



镜总宽

140mm

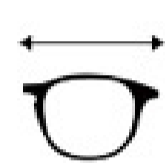

镜片宽

52mm



镜片高

45mm



鼻间距

18mm

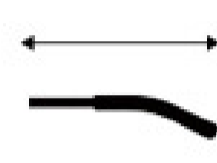

镜腿长

145mm

注：以上尺寸均为手工测量，存在一定的误差，敬请谅解！

## COLOR DISPLAY

### 颜色展示



の

黑枪框

BLACK GUN



の

黑金框

BLACK GOLD

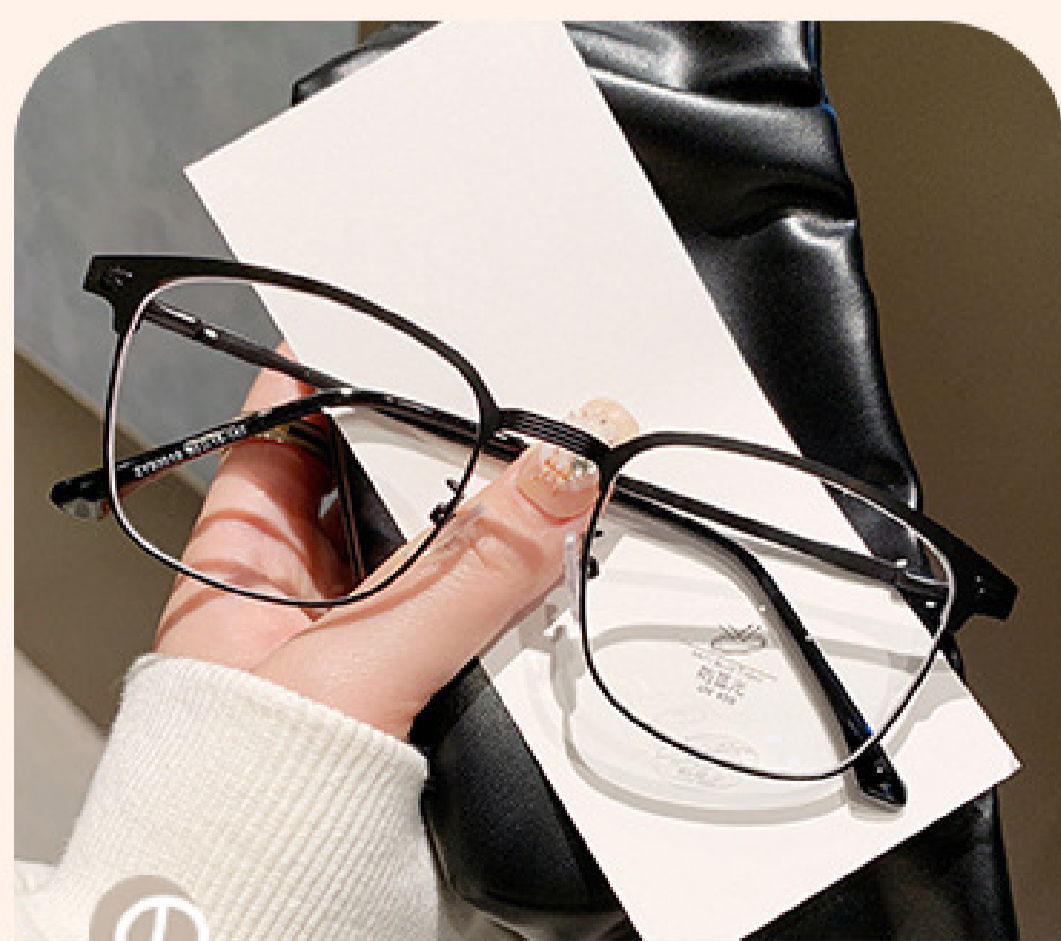

の

黑色框

BLACK



の

黑银框

BLACK SILVER

Information

## 产品信息

产品型号：ZY-11176

眼镜名称：时尚光学镜

眼镜材质：金属+TR

眼镜功能：防蓝光、潮搭、可配镜

更多  
了解



注：以上镜框尺寸数据均为手工测量，  
若有误差在1-3MM内，敬请谅解

## 颜色展示



亮黑金



透灰银



亮黑银



透明银



亮黑枪

PRODUCT  
PARAMETERS

# 产品参数

类型：防蓝光眼镜

镜架材质：TR90+金属

型号：ZY-8156

颜色：5色可选

适合性别：中性

风格：简约



注：因测量方式不同，可能存在微小误差，请以实物为准。

## 可选颜色



亮黑银



亮黑玫瑰金



砂黑银



砂绿银



透明银

# Product Parameters

# 产品参数

产品型号: ZY-0062      产品功能: 防蓝光/装饰

眼镜重量: 26.2g (含镜片)      适合脸型: 通用脸型

镜框材质: 金属+TR      适合性别: 中性



镜总宽

146mm

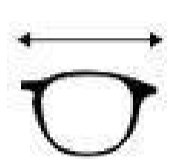

镜片宽

50mm



镜片高

46mm



鼻间距

22mm



镜腿长

142mm

注: 以上尺寸均为手工测量, 存在一定的误差, 敬请谅解!

## COLOR DISPLAY

### 颜色展示



亮黑框



黑金框



黑银框



黑枪框



透灰银框



透明银框

# Product Parameters

# 产品参数

产品型号: ZY-16178

产品功能: 配镜/装饰

眼镜重量: 17.7g (不含镜片)

适合脸型: 通用脸型

镜框材质: 金属+PC

适合性别: 男女同款



镜总宽

145mm

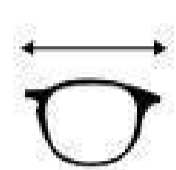

镜片宽

53mm

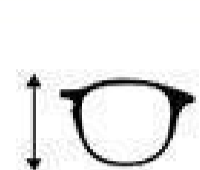

镜片高

42mm



鼻间距

19mm

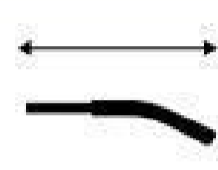

镜腿长

145mm

注: 以上尺寸均为手工测量, 存在一定的误差, 敬请谅解!

## COLOR DISPLAY

### 颜色展示



の 黑银框



の 黑金框



の 黑框



の 黑枪框



の 透明银框



の 透灰银框

## Product Parameters

## 产品参数

产品型号: ZY-8151

产品功能: 配镜/装饰

眼镜重量: 20g(含镜片)

适合脸型: 通用脸型

镜框材质: 金属+TR

适合性别: 男女款



镜总宽

142mm

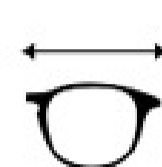

镜片宽

51mm



镜片高

46mm

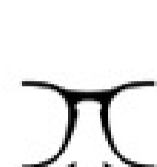

鼻间距

19mm

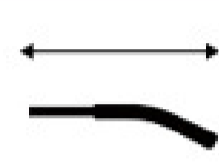

镜腿长

145mm

注: 以上尺寸均为手工测量, 存在一定的误差, 敬请谅解!

## COLOR DISPLAY

### 颜色展示



黑金框

BLACK GOLD



透灰银框

GREY SILVER



茶绿金框

BROWN GREEN GOLD



黑银框

BLACK SILVER



灰茶银框

GREY BROWN SILVER



透明金框

TRANSPARENT GOLD

PRODUCT  
PARAMETERS

# 产品参数

类型：防蓝光眼镜

镜架材质：TR90+金属

型号：ZY-1243

颜色：8色可选

适合性别：中性

风格：简约



镜片高度  
48mm



鼻梁宽度  
16mm



镜框总宽  
140mm



镜片宽度  
54mm



镜腿长度  
143mm



镜框重量  
18.1g

注：因测量方式不同，可能存在微小误差，请以实物为准。

## 可选颜色



黑银框



黑金框



茶金框



粉金框



棕金框



透灰银框



透明银框



透明金框

## Product Parameters

## 产品参数

产品型号：ZY-8019

产品功能：配镜/装饰

眼镜重量：22g(含镜片)

适合脸型：通用脸型

镜框材质：金属

适合性别：男女同款



镜总宽

135mm



镜片宽

50mm



镜片高

45mm



鼻间距

18mm

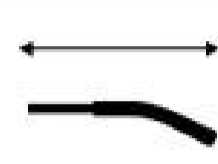

镜腿长

146mm

注：以上尺寸均为手工测量，存在一定的误差，敬请谅解！

## COLOR DISPLAY

### 颜色展示



の 银框



の 金框



の 黑银框



の 玫金框



の 黑框

# Product Parameters

# 产品参数

产品型号: ZY-8028

产品功能: 配镜/装饰

镜框重量: 16.9g

适合脸型: 通用脸型

镜框材质: 金属

适合性别: 男女同款



镜总宽

141mm



镜片宽

55mm



镜片高

50mm



鼻间距

16mm

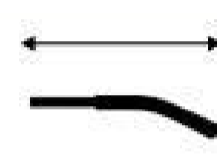

镜腿长

148mm

注: 以上尺寸均为手工测量, 存在一定的误差, 敬请谅解!

## COLOR DISPLAY

### 颜色展示



の 金框



の 黑框



の 玫金框



の 银框

# PRODUCT INFORMATION

## 产品信息

型号：ZY3150

镜片类型：配镜/防蓝光

适合性别：男款

镜架材质：钛

颜色：3色可选

风格：简约、商务



镜片高度  
41mm



鼻梁宽度  
20mm



镜框总宽  
142mm



镜片宽度  
52mm



镜腿长度  
145mm



镜框重量  
约20g

注：因测量方式不同，可能存在微小误差，请以实物为准。

### 可选颜色



黑框



黑枪框



黑金框



黑银框

# PRODUCT INFORMATION

## 产品信息

型号：ZY-122607

镜片类型：配镜/防蓝光

适合性别：男款

镜架材质：钛

颜色：4色可选

风格：简约、商务

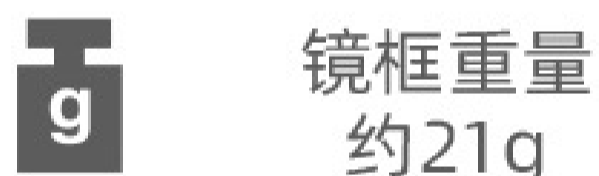

注：因测量方式不同，可能存在微小误差，请以实物为准。

### 可选颜色



黑框



黑枪框



黑金框



黑银框

## Product Parameters

## 产品参数

产品型号: ZY-122606 产品功能: 配镜/装饰

眼镜重量: 21.5g(含镜片) 适合脸型: 通用脸型

镜框材质: 钛

适合性别: 男女款



镜总宽

154mm



镜片宽

52mm



镜片高

43mm



鼻间距

18mm

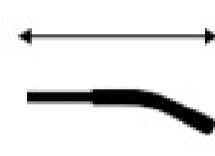

镜腿长

145mm

注: 以上尺寸均为手工测量, 存在一定的误差, 敬请谅解!

## COLOR DISPLAY

### 颜色展示



の

黑金框

BLACK GOLD



の

黑枪框

BLACK GUN



の

黑银框

BLACK SILVER

## Product Parameters

## 产品参数

产品型号：ZY-8219

产品功能：装饰、防蓝光

眼镜重量：16.6g (含镜片)

适合脸型：通用脸型

镜框材质：金属

适合性别：男女



镜总宽

138mm

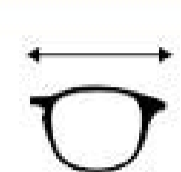

镜片宽

51mm



镜片高

47mm



鼻间距

18mm

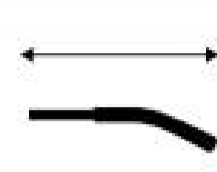

镜腿长

145mm

注：以上尺寸均为手工测量，存在一定的误差，敬请谅解！

## COLOR DISPLAY

### 颜色展示



の 绿色框

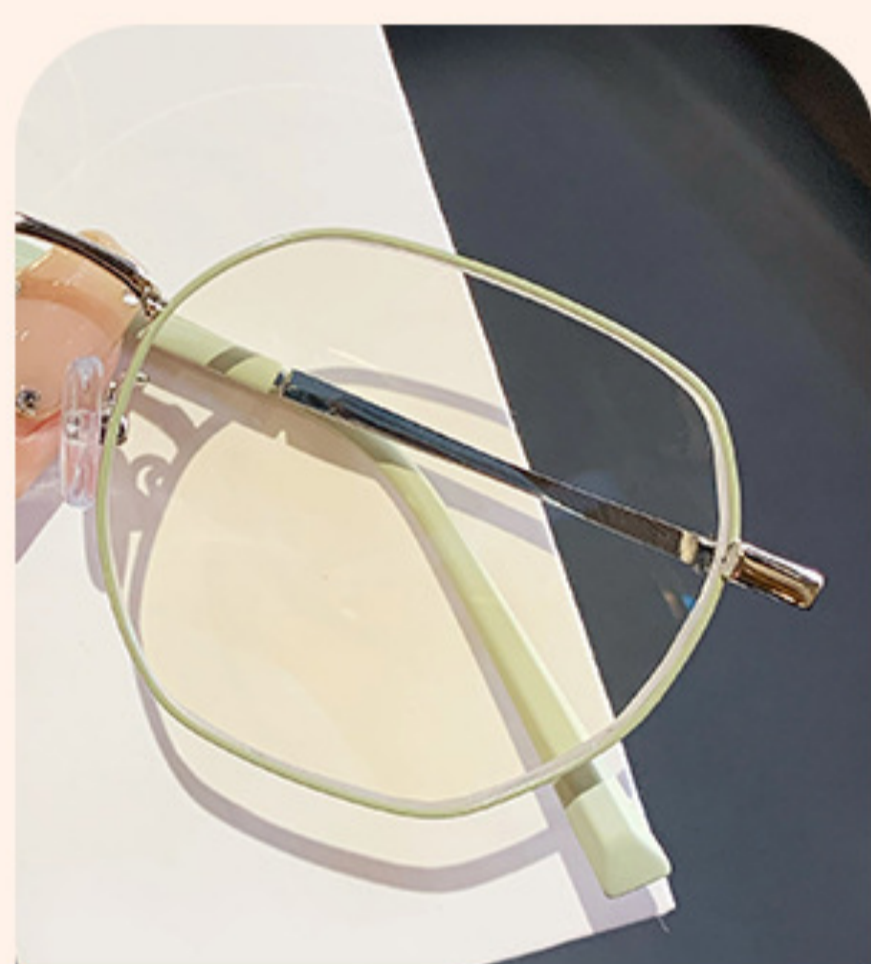

の 绿银框



の 黑色框

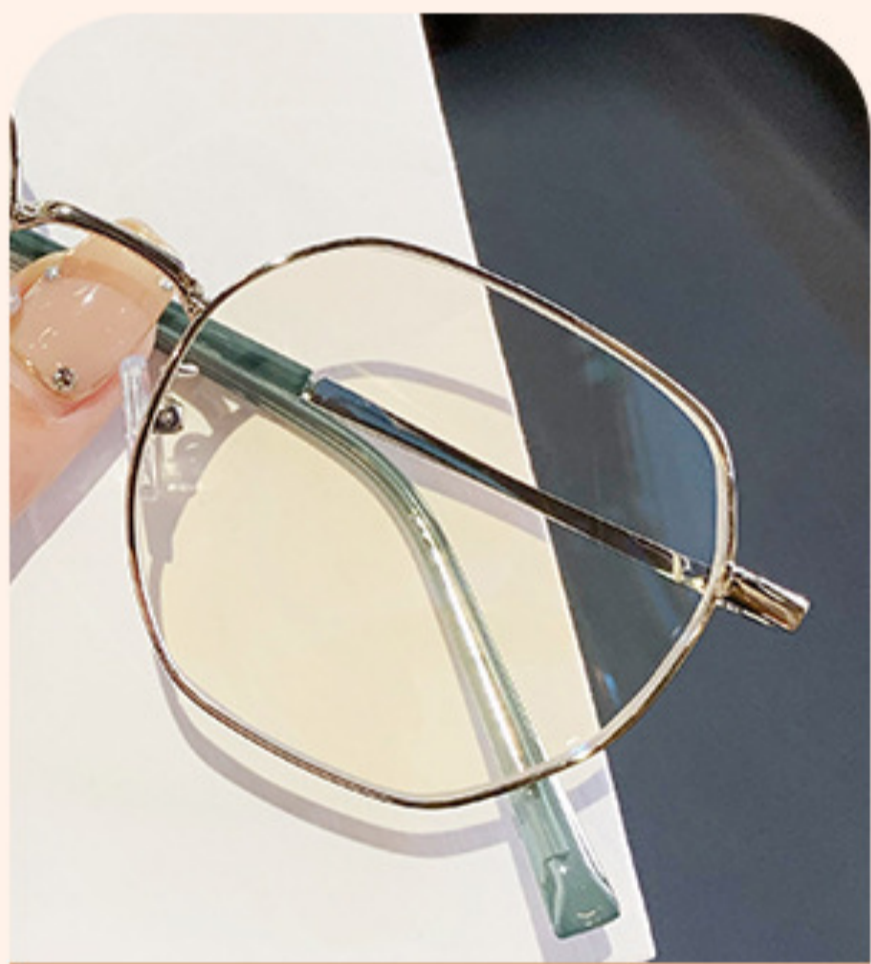

の 银色框



の 卡其金框



の 玫金框



の 黑银框

# PRODUCT INFORMATION

## 产品信息

类型：平光镜

镜片类型：配镜

适合性别：男女

镜架材质：TR+金属

颜色：5色可选

风格：简约

产品型号：ZY-2817



镜片高度  
44mm



鼻梁宽度  
22mm



镜框总宽  
147mm



镜片宽度  
53mm



镜腿长度  
145mm



镜框重量  
约17g

注：因测量方式不同，可能存在微小误差，请以实物为准。

### 可选颜色



砂黑枪色



亮黑枪色



亮黑银色



亮黑金色



玳瑁金色

STAY  
TUNED FOR

PRODUCT  
PARAMETERS

# 产品参数

镜架型号

21092

镜架材质

金属

镜架重量

20.5克

眼镜框型

圆框

适用性别

女款



镜总宽

138mm

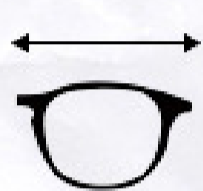

镜框宽

53mm



鼻间距

10mm

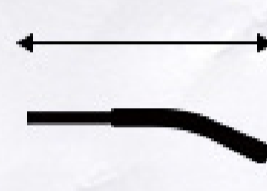

镜腿长

140mm

注: 以上尺寸均为手工测量, 测量的方法不同可能存在1-3mm偏差, 收到请以实物为准。

## 产品展示

PRODUCT  
DISPLAY

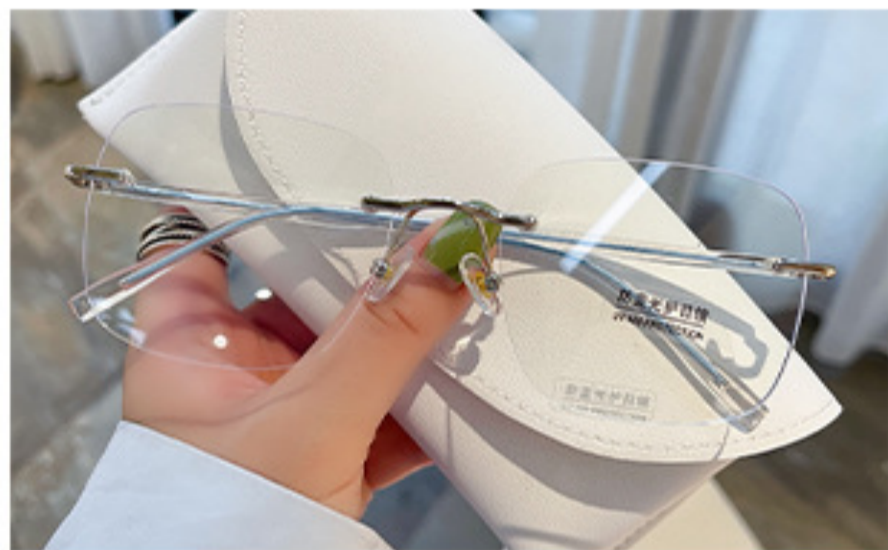

21092-透蓝银框



21092-透黑金框

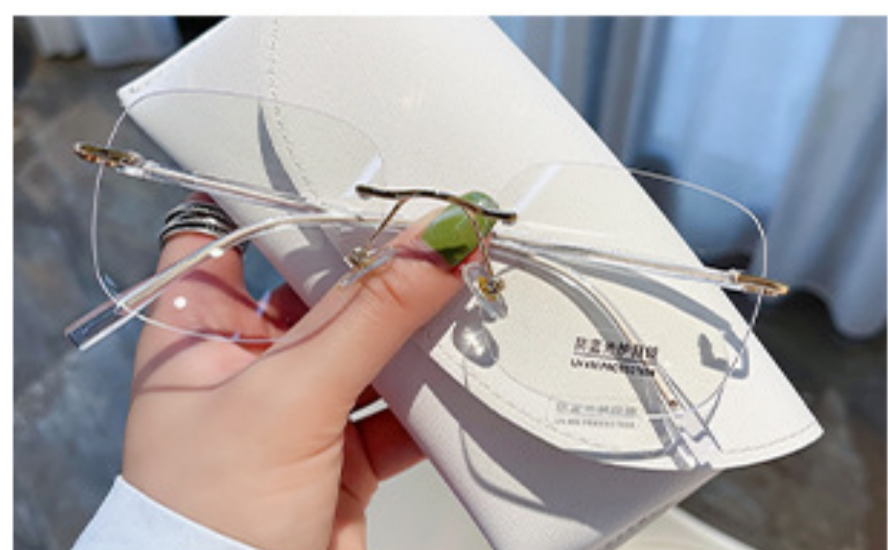

21092-透白金框



21092-黄黑框

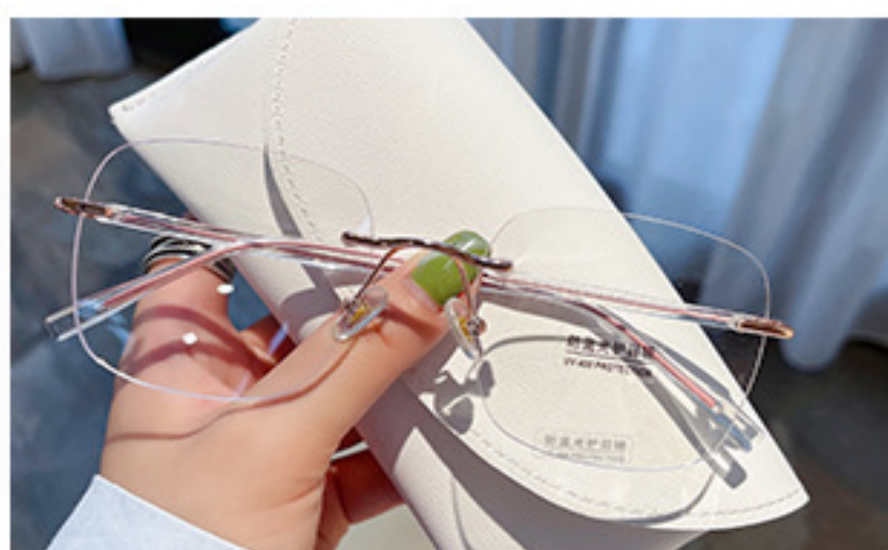

21092-透粉玫瑰金

产品更新中

...

PRODUCT  
PARAMETERS

# 产品参数

类型：防蓝光眼镜

型号：ZY-3099

适合性别：中性

镜架材质：TR90+金属

颜色：6色可选

风格：简约



镜片高度  
48mm



鼻梁宽度  
18mm



镜框总宽  
141mm



镜片宽度  
52mm



镜腿长度  
145mm



镜框重量  
20g

注：因测量方式不同，可能存在微小误差，请以实物为准。

## 可选颜色



亮黑框



透粉框



透明框



透蓝框



透灰框



橄榄绿框

PRODUCT  
PARAMETERS

# 产品参数

类型：防蓝光眼镜

镜架材质：TR90+金属

型号：ZY-3098

颜色：9色可选

适合性别：中性

风格：简约



镜片高度  
48mm



鼻梁宽度  
18mm



镜框总宽  
144mm



镜片宽度  
52mm



镜腿长度  
143mm



镜框重量  
20g

注：因测量方式不同，可能存在微小误差，请以实物为准。

## 可选颜色



亮黑框



渐紫框



渐灰框



透明玫金框

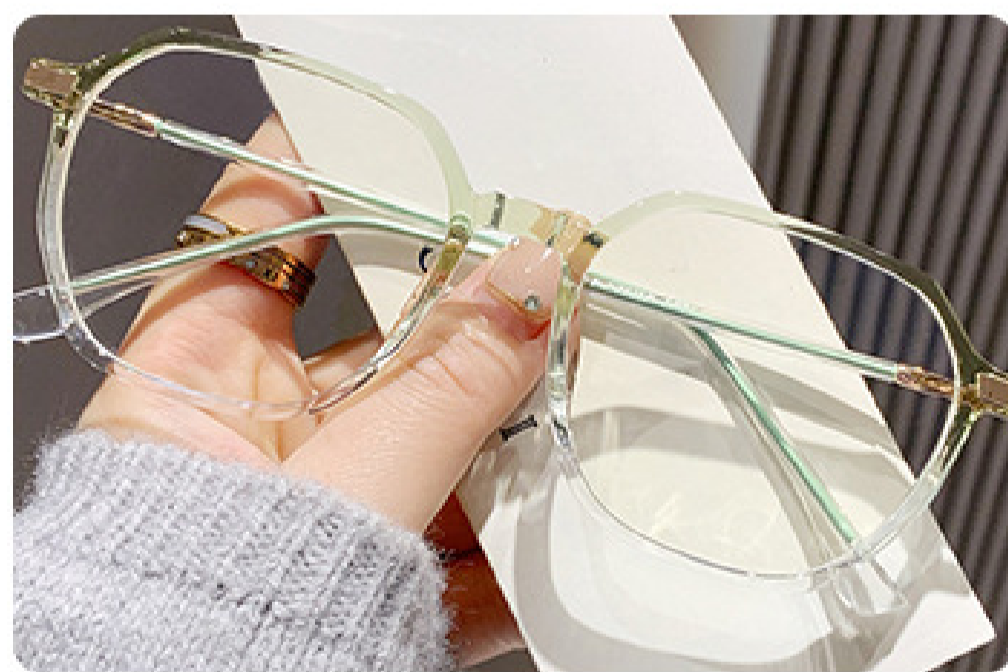

渐绿框



橄榄绿框

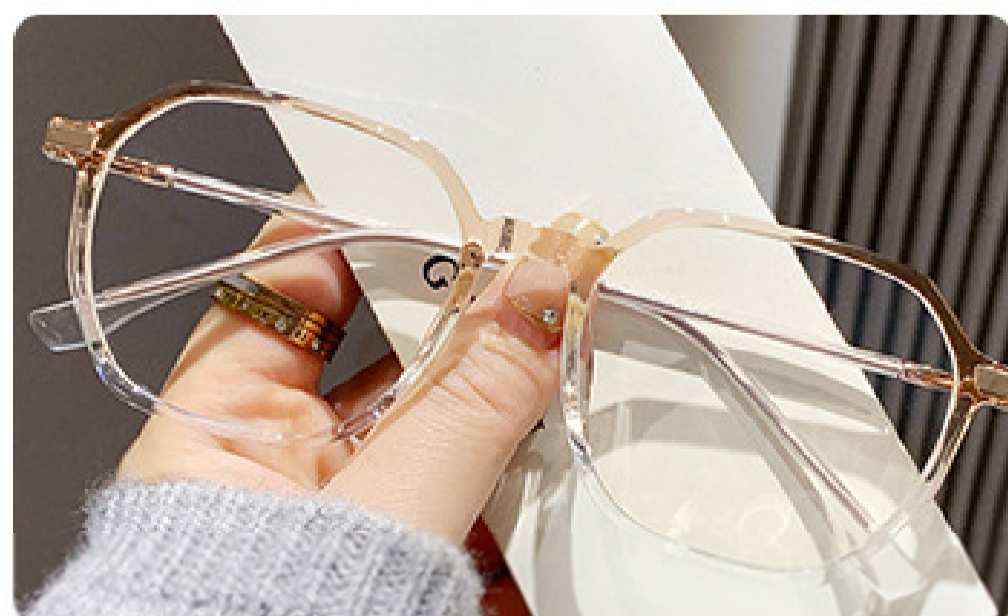

渐茶框

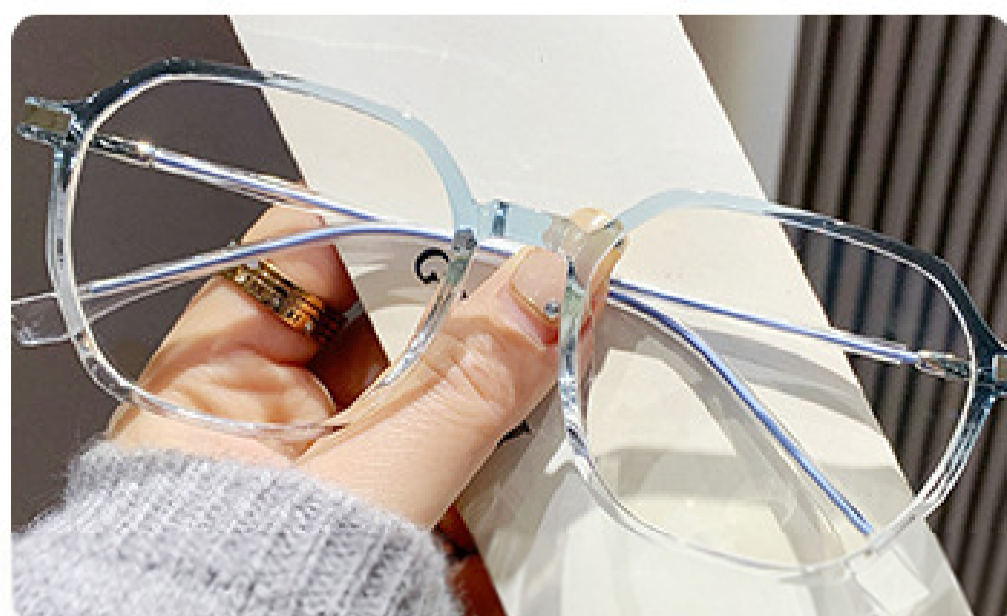

渐蓝框



透明银框

# Product Parameters

# 产品参数

产品型号: ZY-18091

产品功能: 配镜、装饰

眼镜重量: 20g (含镜片)

适合脸型: 通用脸型

镜框材质: 金属

适合性别: 男女



镜总宽

137mm

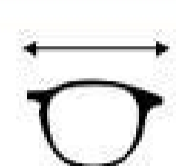

镜片宽

52mm



镜片高

49mm



鼻间距

19mm



镜腿长

145mm

注: 以上尺寸均为手工测量, 存在一定的误差, 敬请谅解!

## COLOR DISPLAY

### 颜色展示

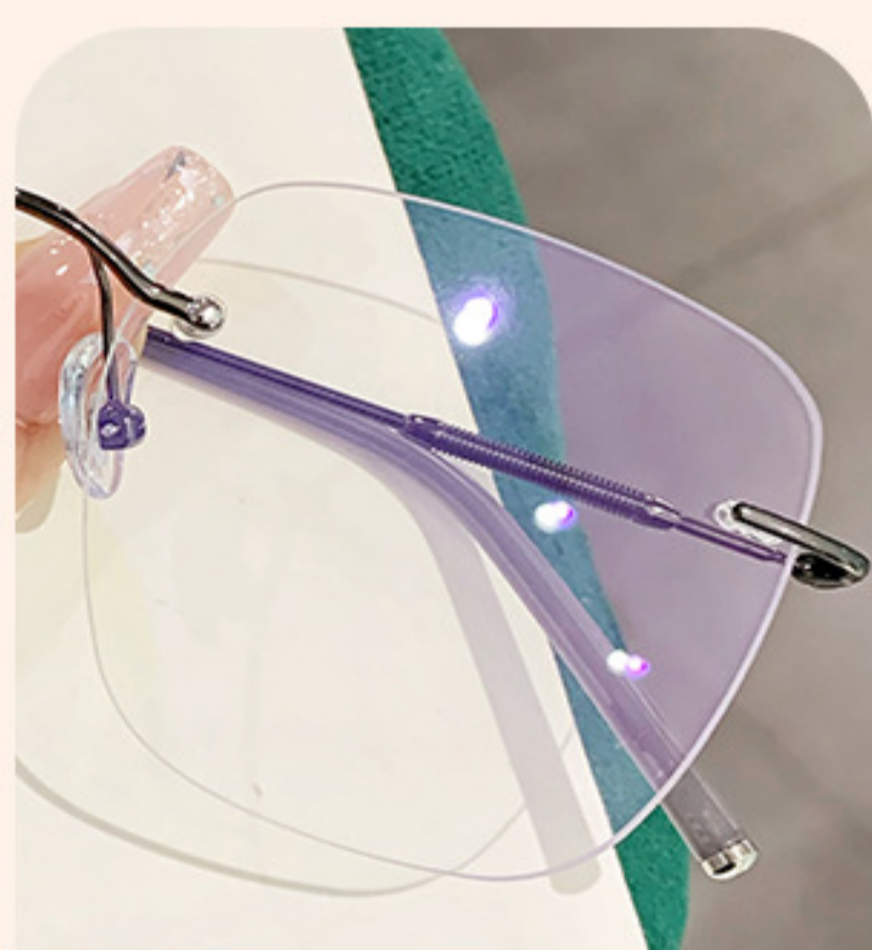

の 枪框

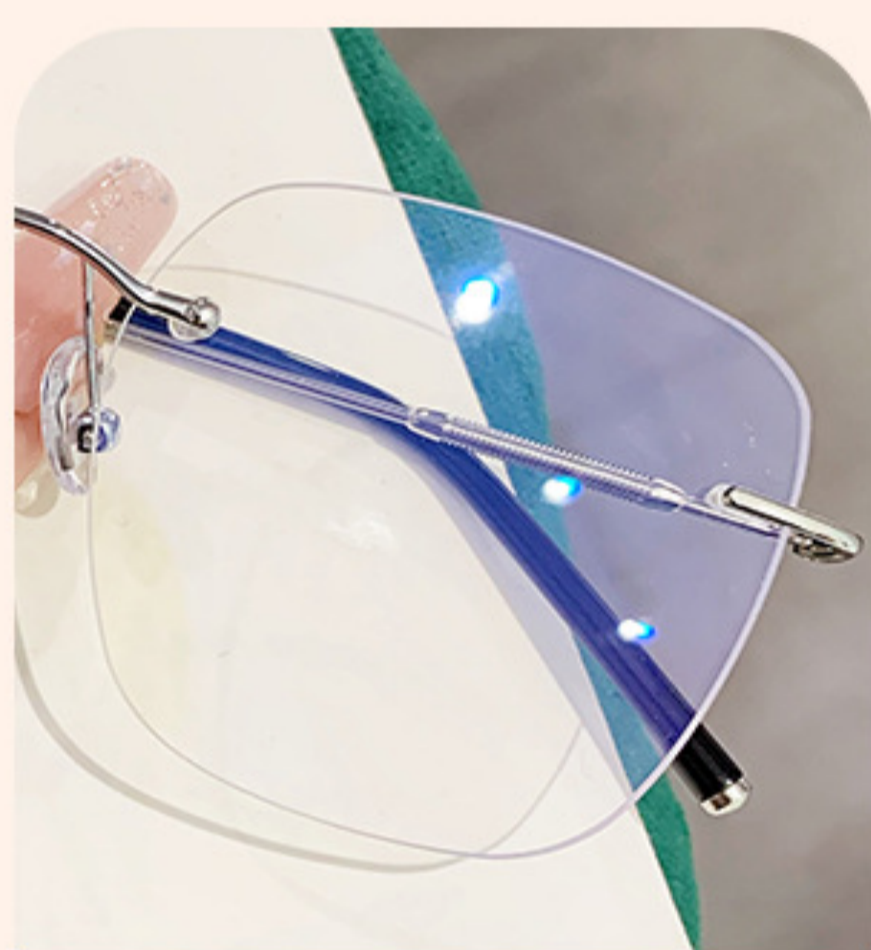

の 银框



の 玫瑰金框

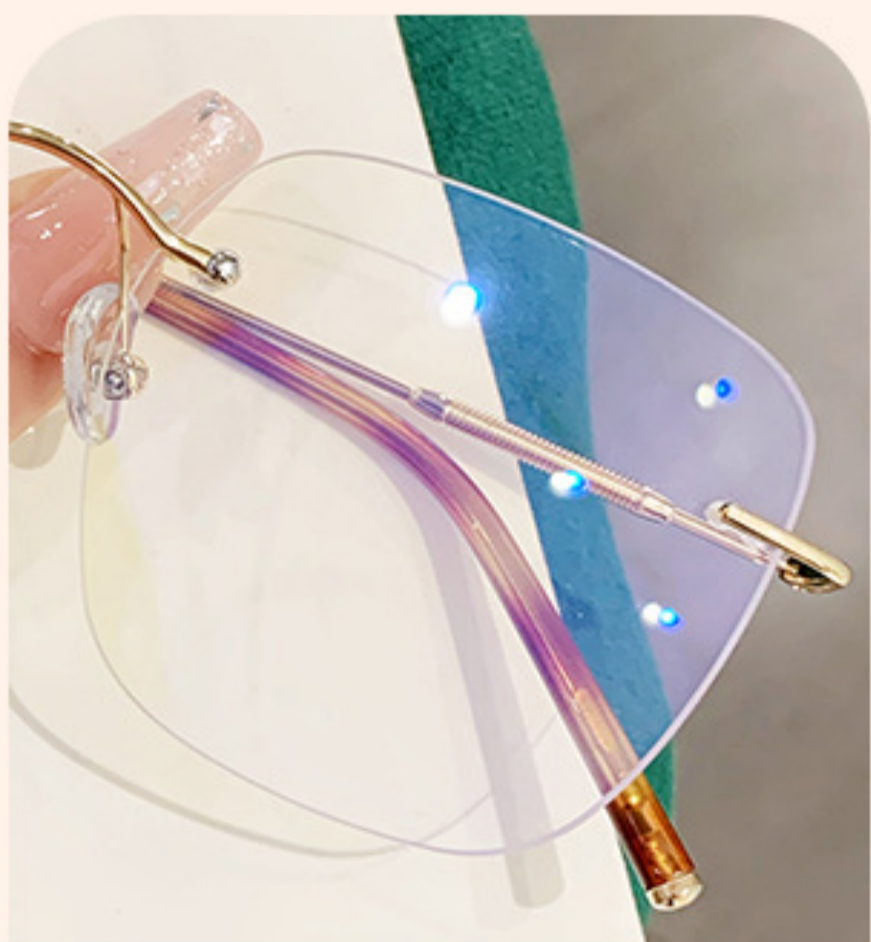

の 金框

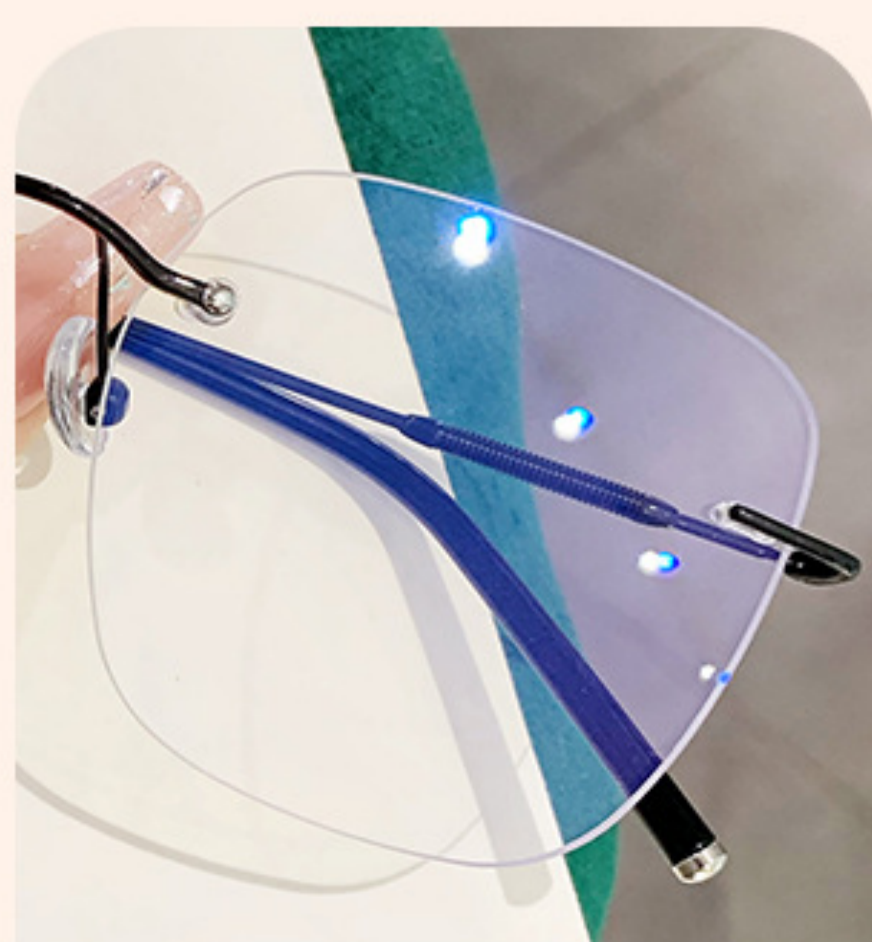

の 黑框

## Product Parameters

## 产品参数

产品型号：ZY-18092

产品功能：潮搭/防蓝光

眼镜重量：20g (含镜片)

适合脸型：通用脸型

镜框材质：金属

适合性别：女性



镜总宽

142mm

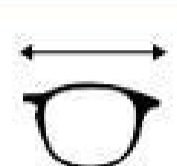

镜片宽

54mm



镜片高

50mm



鼻间距

19mm

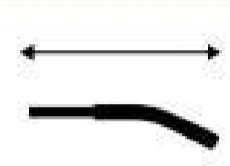

镜腿长

142mm

注：以上尺寸均为手工测量，存在一定的误差，敬请谅解！

## COLOR DISPLAY

### 颜色展示



の 枪框



の 玫瑰金框



の 银框



の 黑框



の 金框

## Product Parameters

## 产品参数

产品型号: ZY-18093

产品功能: 装饰/防蓝光

眼镜重量: 17.4g (含镜片)

适合脸型: 通用脸型

镜框材质: 金属

适合性别: 中性



镜总宽

138mm

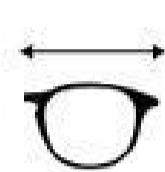

镜片宽

54mm



镜片高

38mm



鼻间距

19mm

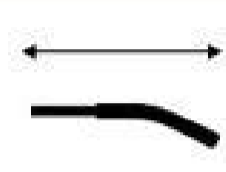

镜腿长

142mm

注: 以上尺寸均为手工测量, 存在一定的误差, 敬请谅解!

## COLOR DISPLAY

### 颜色展示

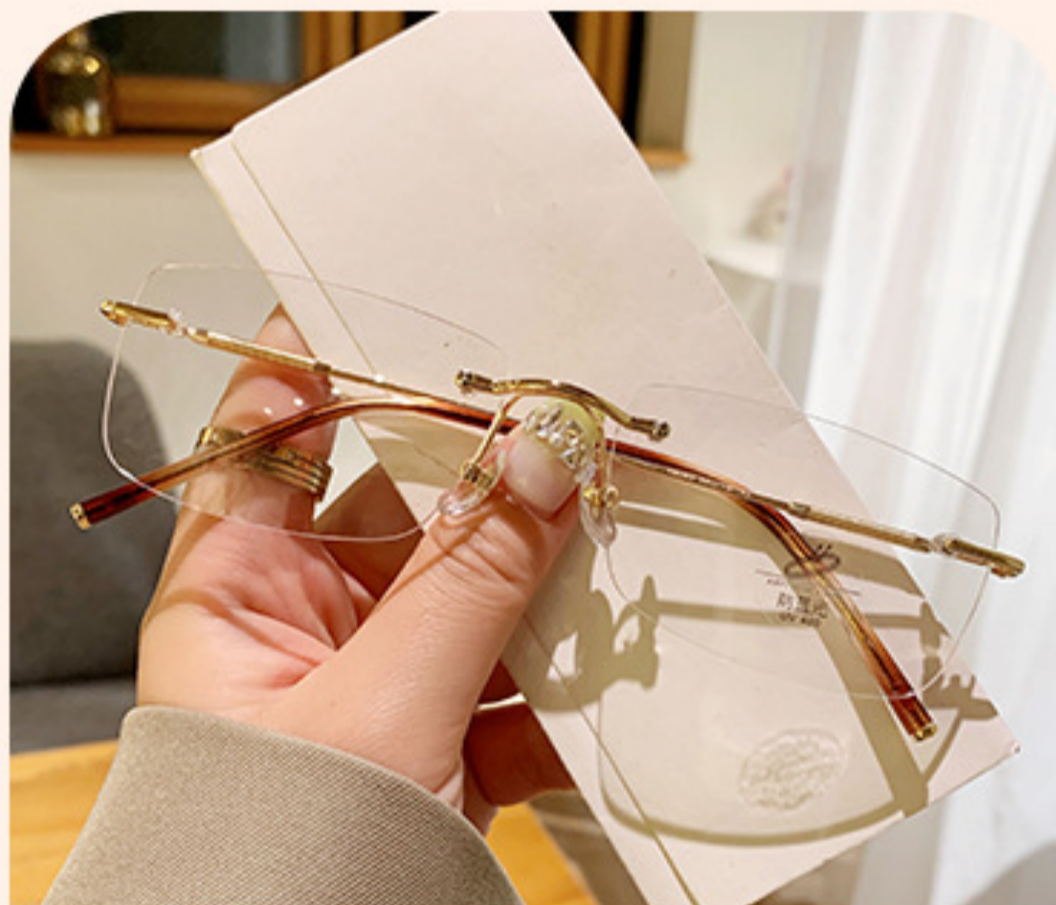

の 金框

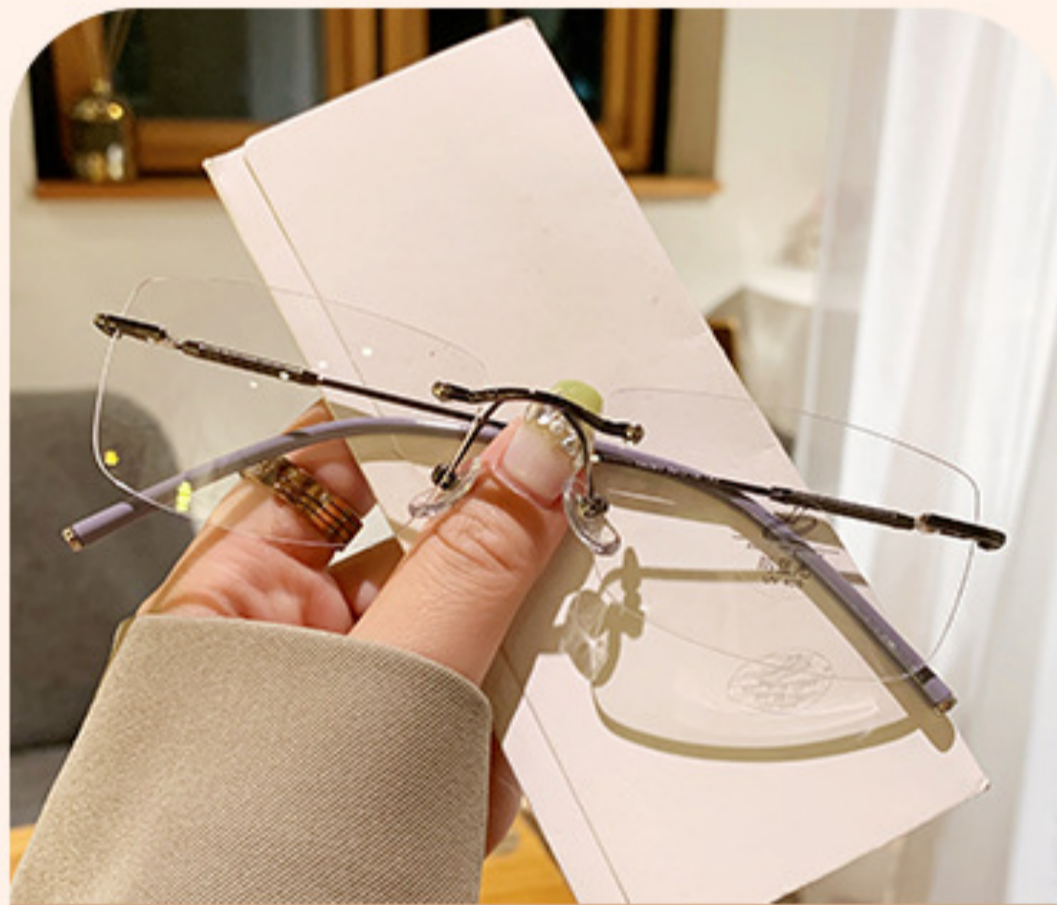

の 枪框



の 黑框

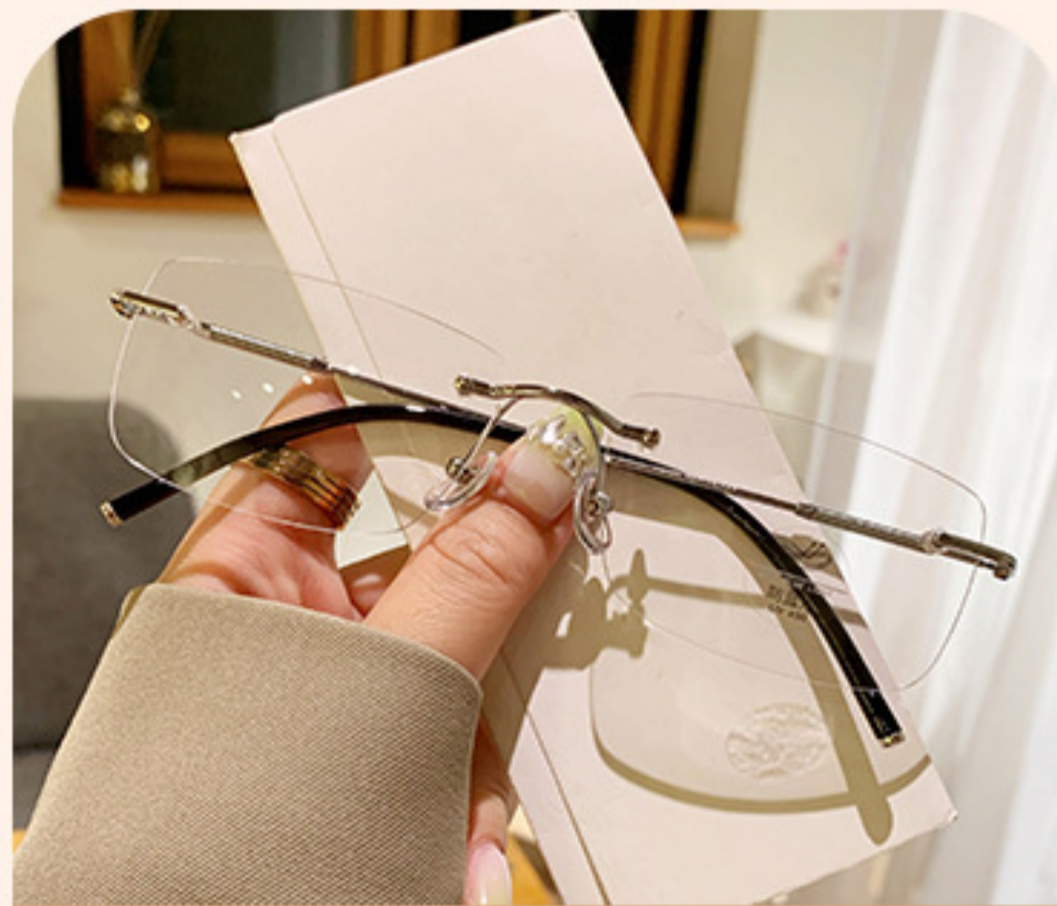

の 银框



の 玫瑰金框

# Product Parameters

# 产品参数

产品型号: ZY-122602

产品功能: 配镜/潮搭

眼镜重量: 21.3g (含镜片)

适合脸型: 通用脸型

镜框材质: 金属

适合性别: 中性



镜总宽

137mm

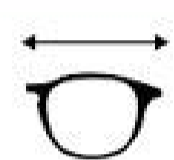

镜片宽

54mm



镜片高

48mm



鼻间距

18mm

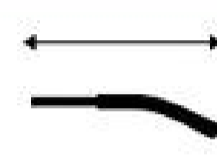

镜腿长

145mm

注: 以上尺寸均为手工测量, 存在一定的误差, 敬请谅解!

## COLOR DISPLAY

### 颜色展示



黑框



枪框



银框



金框



玫瑰金框

# Product Parameters

# 产品参数

产品型号: ZY-122603

产品功能: 防蓝光/装饰

眼镜重量: 20g (含镜片)

适合脸型: 通用脸型

镜框材质: 钛

适合性别: 中性



镜总宽

136mm

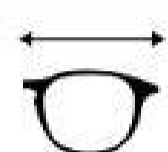

镜片宽

55mm



镜片高

40mm



鼻间距

18mm



镜腿长

145mm

注: 以上尺寸均为手工测量, 存在一定的误差, 敬请谅解!

## COLOR DISPLAY

### 颜色展示



黑框

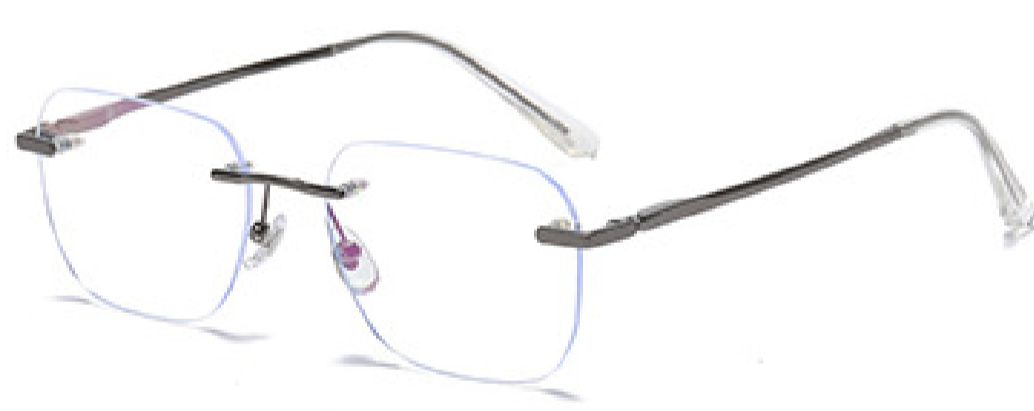

枪框

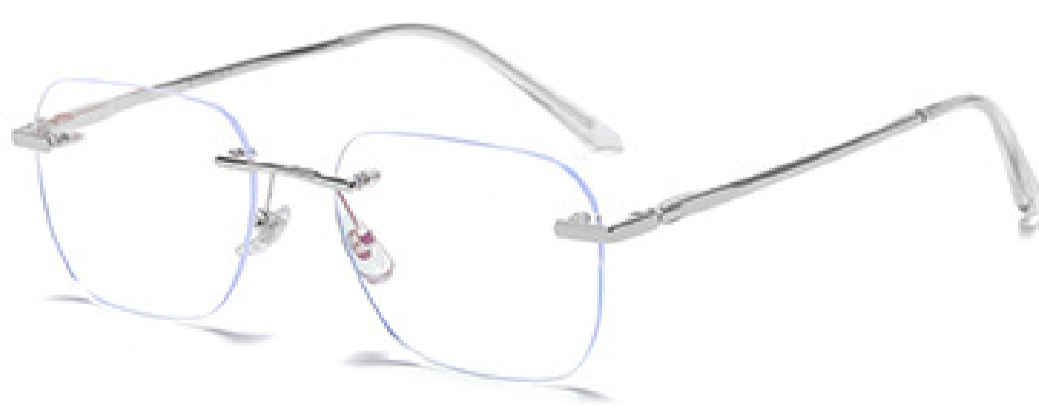

银框



金框



玫瑰金框

## Product Parameters

## 产品参数

产品型号: ZY8027

产品功能: 防蓝光、装饰

眼镜重量: 20.6g (不含镜片)

适合脸型: 通用脸型

镜框材质: 金属

适合性别: 男女



镜总宽

138mm

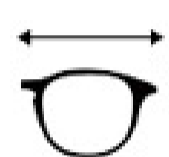

镜片宽

51mm



镜片高

48mm



鼻间距

19mm

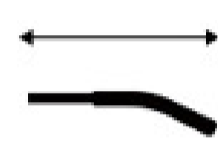

镜腿长

147mm

注: 以上尺寸均为手工测量, 存在一定的误差, 敬请谅解!

## COLOR DISPLAY

### 颜色展示



の 金框



の 玫金框



の 黑金框



の 银框

# Product Parameters

# 产品参数

产品型号：ZY8022

产品功能：装饰、配镜

眼镜重量：20.5g (含镜片)

适合脸型：通用脸型

镜框材质：金属

适合性别：中性



镜总宽

140mm



镜片宽

51mm



镜片高

37mm



鼻间距

22mm



镜腿长

145mm

注：以上尺寸均为手工测量，存在一定的误差，敬请谅解！

## COLOR DISPLAY

### 颜色展示



の 金框



の 银框



の 黑框

# Product Parameters

# 产品参数

产品型号：ZY-58109

产品功能：防蓝光、装饰

眼镜重量：13.8g (不含镜片)

适合脸型：通用脸型

镜框材质：金属

适合性别：男女



镜总宽

135mm

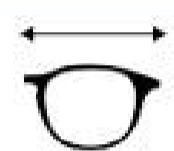

镜片宽

50mm



镜片高

45mm



鼻间距

19mm

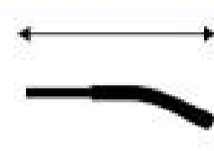

镜腿长

143mm

注：以上尺寸均为手工测量，存在一定的误差，敬请谅解！



の 黑银



の 玫瑰金



の 黑金

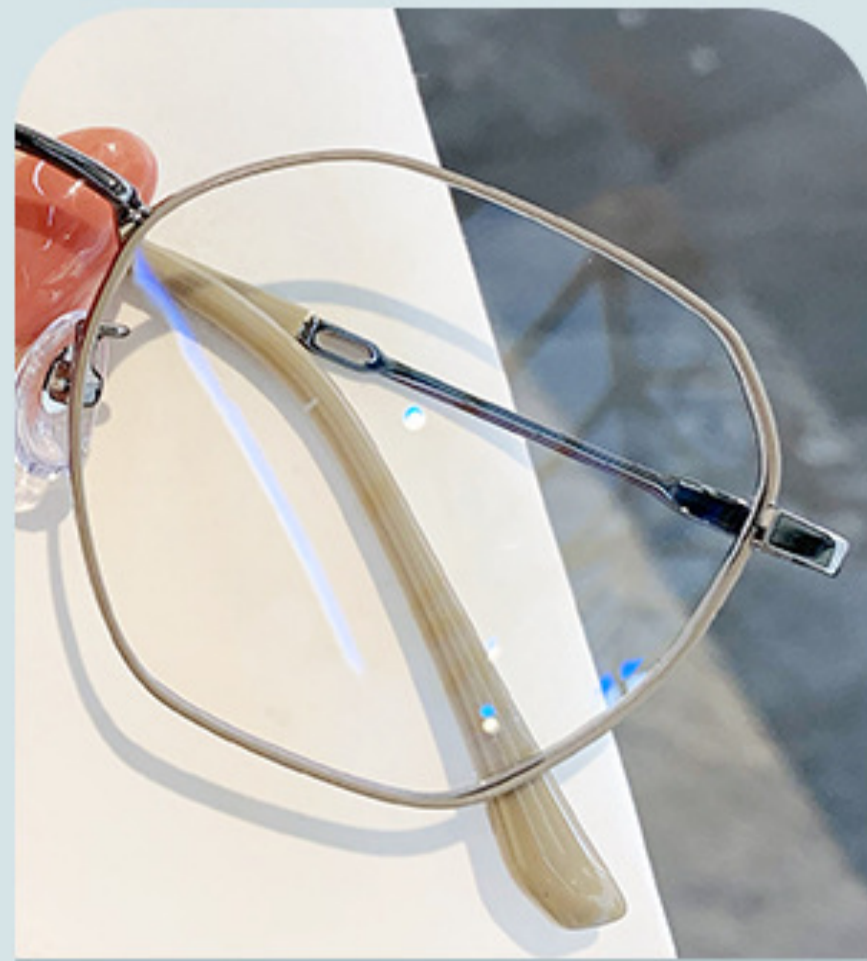

の 橄榄绿枪

## Product Parameters

## 产品参数

产品型号: ZY-58078

产品功能: 防蓝光、装饰

眼镜重量: 21.1g (含镜片)

适合脸型: 通用脸型

镜框材质: 金属

适合性别: 通用



镜总宽

136mm

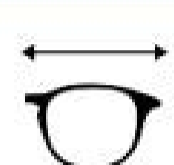

镜片宽

53mm



镜片高

47mm



鼻间距

19mm

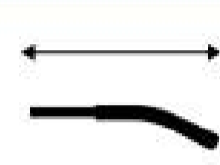

镜腿长

143mm

注: 以上尺寸均为手工测量, 存在一定的误差, 敬请谅解!

## COLOR DISPLAY

### 颜色展示



の 青茶银框



の 黑银框



の 黑框



の 玫瑰金框



の 黑金框

## Product Parameters

## 产品参数

产品型号: ZY-18070

产品功能: 装饰、可配镜

眼镜重量: 13.5g (不含镜片) 适合脸型: 通用脸型

镜框材质: 金属

适合性别: 通用款



镜总宽

136mm

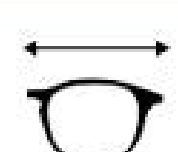

镜片宽

55mm

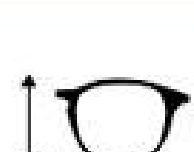

镜片高

44mm



鼻间距

18mm

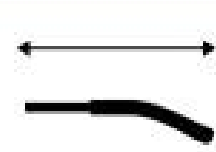

镜腿长

144mm

注: 以上尺寸均为手工测量, 存在一定的误差, 敬请谅解!

## COLOR DISPLAY

### 颜色展示



の 黑色



の 黑银色



の 奶茶金

の 黑金色



# Product Parameters

# 产品参数

产品型号：ZY-8007

产品功能：防蓝光、配镜

眼镜重量：21g (含镜片)

适合脸型：通用脸型

镜框材质：金属

适合性别：通用



镜总宽

140mm

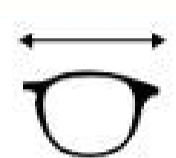

镜片宽

54mm



镜片高

51mm



鼻间距

17mm

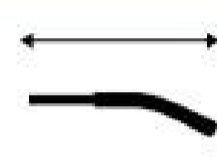

镜腿长

145mm

注：以上尺寸均为手工测量，存在一定的误差，敬请谅解！

## COLOR DISPLAY

### 颜色展示



の 金框



の 黑框



の 银框



の 玫瑰金框

# INFORMATION

## 产品信息



性别 / 中性

镜框材质 / 金属

功能 / 配镜、装饰

镜框重量 / 15g

型号 / ZY-122605



① 42mm    ② 17mm    ③ 140mm    ④ 53mm    ⑤ 145mm

## AVAILABLE COLOR



黑金框



黑银框



黑枪框



黑框

## Product Parameters

## 产品参数

产品型号: ZY-21606

产品功能: 防蓝光、装饰

眼镜重量: 18.2g (含镜片)

适合脸型: 通用脸型

镜框材质: 金属

适合性别: 男女



镜总宽

140mm



镜片宽

54mm



镜片高

37mm



鼻间距

19mm

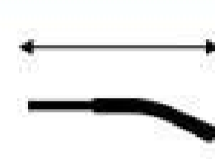

镜腿长

146 mm

注: 以上尺寸均为手工测量, 存在一定的误差, 敬请谅解!

## COLOR DISPLAY

### 颜色展示



の 黑框

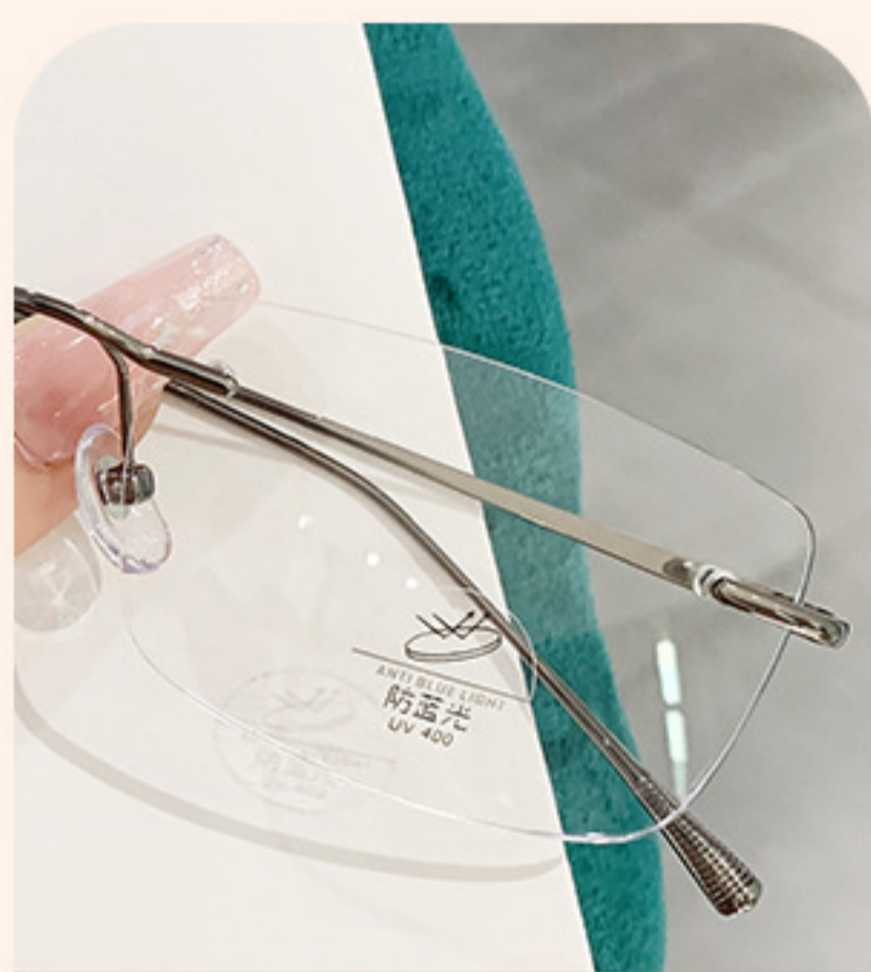

の 枪框



の 玫瑰金框



の 金框



の 银框

# PRODUCT INFO

## 产品信息



\*以上参数属于手工测量。允许存在一定合理范围内误差，具体以实物为准

型号：ZY-6218

材质：金属

重量：18.2g(含镜片)

性别：男女通用

风格：时尚

功能：防蓝光

## 可选颜色

OPTIONAL COLOR



银框



金框



枪框



黑框



玫瑰金框

# PRODUCT INFO

## 产品信息



\*以上参数属于手工测量。允许存在一定合理范围内误差，具体以实物为准

型号：ZY-6217

材质：金属

重量：18.1g(含镜片)

性别：男女通用

风格：时尚

功能：防蓝光

## 可选颜色

OPTIONAL COLOR



银框



金框



枪框



黑框



玫瑰金框

# INFORMATION

## 参数信息



产品编号/MODEL: ZY-6215

镜框材质/MATERIAL: Metal

镜框重量/WHIGHT: 18.6g

适合人群/SUITABLE: General

镜框参数:



注: 以上参数均属手工测量, 如有误差1-3MM, 均属正常, 具体以实物为准!

## COLOR 可选颜色



BLACK/黑框



SILVER/银框



ROSE GOLD/玫瑰金框



GOLD/金框

# PRODUCT INFORMATION

## 产品信息

类型：防蓝光

镜架材质：金属

镜片类型：配镜

颜色：5色可选

适合性别：男女通用

风格：简约

产品型号：ZY-3558



镜片高度  
42mm



鼻梁宽度  
18mm



镜框总宽  
142mm



镜片宽度  
54mm



镜腿长度  
150mm



镜框重量  
约16g

注：因测量方式不同，可能存在微小误差，请以实物为准。

### 可选颜色



亮黑框



亮黑金框



亮黑银框



亮黑枪框



砂黑枪框

# Product Parameters

# 产品参数

产品型号: ZY-9003

产品功能: 装饰、防蓝光

眼镜重量: 21.3g (含镜片)

适合脸型: 通用脸型

镜框材质: 金属

适合性别: 通用款



镜总宽

133mm

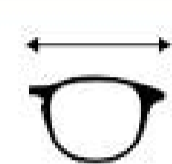

镜片宽

52mm



镜片高

50mm



鼻间距

17mm



镜腿长

143mm

注: 以上尺寸均为手工测量, 存在一定的误差, 敬请谅解!

## COLOR DISPLAY

### 颜色展示



の 黑金框



の 银框



の 黑银框



の 金框



の 玫金框

## Product Parameters

## 产品参数

产品型号: ZY-9085

产品功能: 防蓝光、装饰

眼镜重量: 17.9g (不含镜片) 适合脸型: 通用脸型

镜框材质: TR+金属 适合性别: 男女



镜总宽

138mm

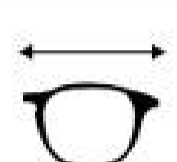

镜片宽

52mm



镜片高

42mm



鼻间距

17mm

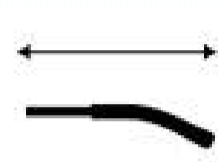

镜腿长

150mm

注: 以上尺寸均为手工测量, 存在一定的误差, 敬请谅解!

## COLOR DISPLAY

### 颜色展示



の 黑银框



の 灰银框



の 透明银



の 透明金



の 黑金框

PRODUCT  
PARAMETERS

# 产品参数

类型：防蓝光眼镜  
型号：ZY-68087  
适合性别：中性

镜架材质：TR90+金属  
颜色：5色可选  
风格：简约

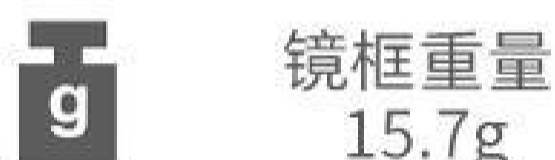

注：因测量方式不同，可能存在微小误差，请以实物为准。

## 可选颜色



亮黑框



玳瑁框



砂黑框



透茶框



透明框

# INFORMATION

## 参数信息



产品编号/MODEL: ZY-9531

镜框材质/MATERIAL: TR+Metal

镜框重量/WHIGHT: 9.2g

适合人群/SUITABLE: Female

镜框参数:



注: 以上参数均属手工测量, 如有误差1-3MM, 均属正常, 具体以实物为准!

## COLOR 可选颜色



BLACK GOLD/亮黑金框



BROWN SILVER/茶银框



TRANSPARENT GOLD/透明金框



BROWN GOLD/渐茶金框



GREY SILVER/灰银框



BLACK SILVER/砂黑银框

# INFORMATION

## 参数信息



产品编号/MODEL: ZY9697

镜框材质/MATERIAL: TR+Metal

镜框重量/WHIGHT: 12.4g

适合人群/SUITABLE: Unisex

镜框参数: .....



注: 以上参数均属手工测量, 如有误差1-3MM, 均属正常, 具体以实物为准!

## 可选颜色

OPTIONAL COLOR



... Color ...  
/ 黑枪框 /



... Color ...  
/ 黑银框 /



... Color ...  
/ 黑金框 /



... Color ...  
/ 黑框 /

PRODUCT  
PARAMETERS

# 产品参数

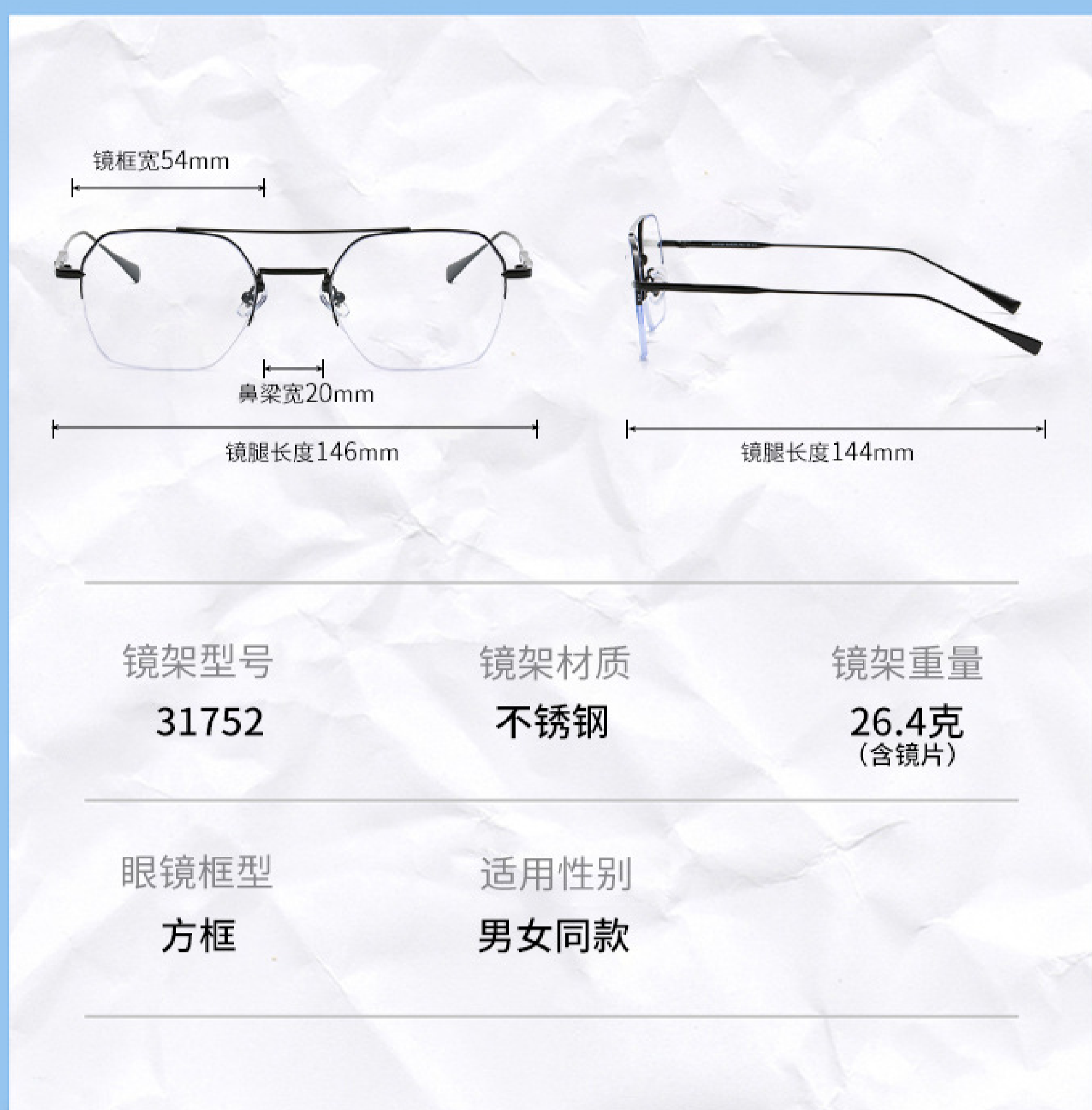

注: 以上尺寸均为手工测量, 测量的方法不同可能存在1-3mm偏差, 收到请以实物为准。

# 产品展示

PRODUCT  
DISPLAY



31752 - 黑框



31752 - 银框



31752 - 黑金框



31752 - 黑银框



31752 - 玫瑰金



31752 - 金框

# PRODUCT INFORMATION

## 产品信息

类型：防蓝光

镜片类型：配镜

适合性别：男

产品型号：ZY-7511

镜架材质：金属

颜色：4色可选

风格：简约

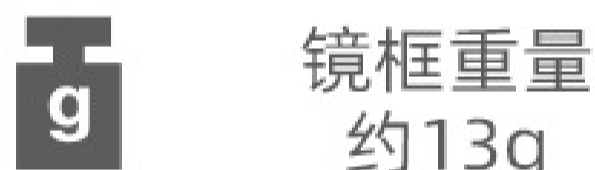

注：因测量方式不同，可能存在微小误差，请以实物为准。

## COLOR 可选颜色



黑框



黑枪框



黑银框



黑金框

# 产品信息

Anti-blue light  
flat  
mirror

//



- 产品类型 防蓝光变色
- 型号 ZY-9187
- 镜片类型 变色、防蓝光
- 使用人群 男女同款
- 产品重量 12g
- 框型材质 金属
- 眼镜框型 圆形

## 产品尺寸



注: 以上尺寸均为手工测量, 测量的方法不同可能存在1-3mm偏差, 收到请以实物为准。

## 适合多种脸型



## 颜色展示



黑框防蓝光



黑金框防蓝光



黑银框防蓝光



黑框变色防蓝光



黑金框变色防蓝光



黑银变色防蓝光

# PRODUCT INFORMATION

## 产品信息

类型：平光镜

镜架材质：金属

镜片类型：配镜

颜色：6色可选

适合性别：男女

风格：简约

产品型号：ZY-9957

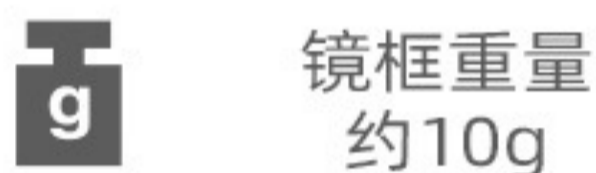

注：因测量方式不同，可能存在微小误差，请以实物为准。

## COLOR 可选颜色



黑框



粉金框



黑金框



金框



黑银框



银框

# PRODUCT INFORMATION

## 产品信息

类型：防蓝光平光镜

镜片类型：抵御蓝光

适合性别：男女同款

产品型号：ZY-9038

镜框材质：金属

颜色：7色可选

风格：简约时尚

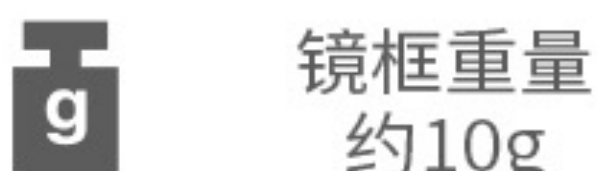

注：因测量方式不同，可能存在微小误差，请以实物为准。

### 可选颜色



黑色



上黑下银



银色



黑银色



黑金色



金色



玫瑰金

STAY  
TUNED FOR

# PRODUCT INFORMATION

## 产品信息



型 号： ZY-9029

眼镜框型： 眉形框

眼镜功能： 防蓝光、变色

适合人群： 男女通用

产品重量： 11.3g (不含镜片)

注：

以上参数均属人工测量

允许存在一定误差，具体以实物为准

## 可选颜色



金色框变色片



粉金框变色片



黑金框变色片



黑银框变色片



咖金框变色片



黑色框变色片

# PRODUCT INFORMATION

## 产品信息

类型：防蓝光平光镜

镜框材质：金属

镜片类型：抵御蓝光

颜色：4色可选

适合性别：男女同款

风格：简约时尚

产品型号：ZY-8820



镜片高度  
43mm



鼻梁宽度  
21mm



镜框总宽  
142mm



镜片宽度  
50mm



镜腿长度  
145mm

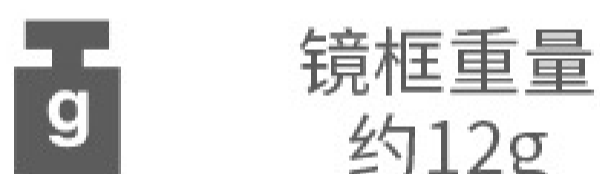

镜框重量  
约12g

注：因测量方式不同，可能存在微小误差，请以实物为准。

### 可选颜色



黑色



蓝银色



黑银色



黑金色

PRODUCT  
PARAMETERS

# 产品参数



镜架型号  
8808

镜架材质  
金属

镜架重量  
19.2克

眼镜框型  
几何框

适用性别  
女款

注: 以上尺寸均为手工测量, 测量的方法不同可能存在1-3mm偏差, 收到请以实物为准。

## 产品展示

PRODUCT  
DISPLAY



# 产品参数信息

我们用认真的态度打造一款眼镜  
为了您的佩戴舒适



• 产品型号/Model

ZY-8806

• 镜架材质/Frame

金属+PC脚套

• 镜片材质/Lens

防蓝光镜片

• 产品重量/Weight

约14.5g(不含镜片)

• 适用人群/Unsex

男女同款

颜色分类 COLOR CLASSIFICATION



黑金框



黑色框



黑银框



产品型号	镜架材质	镜片材质	眼镜重量	适合脸型
8805	金属	PC	17.9g	通用

⚠ PS: 以上尺寸均属手工测量, 允许误差在1-3mm内, 具体以实物为准



金画黑



金色框



玫瑰金框



黑色框



银画黑

# PRODUCT INFORMATION

## 产品信息

类型：平光镜  
镜片类型：配镜  
适合性别：男女  
产品型号：ZY-5022

镜架材质：金属  
颜色：5色可选  
风格：简约



注：因测量方式不同，可能存在微小误差，请以实物为准。

### 可选颜色



黑色



黑玫瑰金色



玫瑰金色



黑银色



银色

# PRODUCT INFORMATION

## 产品信息

类型：眼镜框

镜框材质：金属

镜片类型：抵御蓝光

颜色：5色可选

适合性别：男女同款

风格：时尚复古

产品型号：ZY-5021



镜片高度  
46mm



鼻梁宽度  
18mm



镜框总宽  
136mm



镜片宽度  
51mm



镜腿长度  
144mm

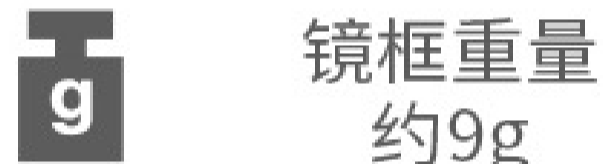

镜框重量  
约9g

注：因测量方式不同，可能存在微小误差，请以实物为准。  
临海市梓悦眼镜厂  
shop70g40n62j0633.1688.com

### 可选颜色



玫瑰金



亮黑色



金色



黑金色



黑银色



银色

临海市梓悦眼镜厂  
shop70g40n62j0633.1688.com

# 产品信息

Anti-blue light  
flat  
mirror

//



- 产品类型 防蓝光变色眼镜
- 产品重量 11g
- 型号 ZY-3617
- 框型材质 不锈钢材质
- 镜片类型 防蓝光、变色
- 眼镜框型 方形

## 产品尺寸



注: 以上尺寸均为手工测量, 测量的方法不同可能存在1-3mm偏差, 收到请以实物为准。

## COLOR 可选颜色



黑框



黑金框



黑银框



金框



银框

# Information/产品参数



(注：纯手工测量如有误差，敬请谅解！)

- 产品型号：ZY3022
- 镜框材质：TR+合金
- 适合性别：通用
- 产品重量：10.6G(不含镜片)
- 产品功能：可配近视
- 适合脸型：多种脸型

## Color/颜色分类



@黑金框



@黑银框



@渐变茶玫瑰金框



@渐变紫玫瑰金框



@渐变绿金框



@渐变粉玫瑰金框



@透明玫瑰金框



@透灰银框



@渐变蓝银框

潮流时尚 上脸美腻

# INFORMATION

## 产品信息

产品型号： ZY-30071

适合人群： 男女款

镜片功能： 防蓝光镜片

镜框材质： TR

眼镜风格： 时髦单品

镜架重量： 18g



## 可选颜色



黑金框



黑银框



香槟金框



透灰框



透明框



透明玫瑰金框



透灰框变色片

## 产品信息



镜架型号: ZY-30031

镜框材质: 不锈钢+TR

眼镜重量: 约14.4克

适合性别: 男款

尺寸参数: 如图所示

产品类别: 变色防蓝光



注: 以上尺寸均为手工测量, 测量的方法不同可能存在1-3mm偏差, 收到请以实物为准。

## 产品展示



型号-30031 (黑色)

镜框/黑色

镜腿/黑色



型号-30031 (黑银)

镜框/黑银

镜腿/黑银



型号-30031 (黑金)

镜框/黑金

镜腿/黑金





## INFORMATION/产品信息

产品型号：ZY2053

适合脸型：各种脸型

适合性别：男女同款

产品功能：可配近视

眼镜重量：11.8g  
(不包括镜片)

镜框材质：TR+金属

尺寸对照表

镜框总宽	镜片宽	镜框高	鼻梁宽	镜腿长
142mm	51mm	48mm	16mm	146mm

注：以上尺寸均为手工测量，每个测量方法不同可能存在1-3mm误差

## COLOR/可选颜色



透明白



透明粉



透明灰



透明黄



透明茶



透明紫



透明蓝



亮黑色

GOOD PRODUCT DETAILS ARE VISIBLE



PRODUCT  
PARAMETERS

# 产品参数

类型：防蓝光眼镜

镜架材质：金属

型号：ZY-20018

颜色：6色可选

适合性别：中性

风格：简约



镜片高度  
42mm



鼻梁宽度  
18mm



镜框总宽  
134mm



镜片宽度  
47mm



镜腿长度  
145mm



镜框重量  
23g

注：因测量方式不同，可能存在微小误差，请以实物为准。

## 可选颜色



... Color ...  
/ 黑银框腮红片 /



... Color ...  
/ 黑金框腮红片 /



... Color ...  
/ 黑框腮红片 /



Color ... ..  
/ 金框腮红片 /



... Color ...  
/ 银框腮红片 /



... Color ...  
/ 玫瑰金框腮红片 /

# PRODUCT INFORMATION

## 产品信息



型号: ZY-1912

眼镜框型: 圆形框

眼镜功能: 防蓝光、变色

适合人群: 男女通用

产品重量: 11.3g (不含镜片)

注:

以上参数均属人工测量

允许存在一定误差, 具体以实物为准

## 可选颜色



黑银框变色片



金色框变色片



银色框变色片



黑金框变色片



黑色框变色片

# 产品信息

Anti-blue light  
flat  
mirror

//



- 产品类型 防蓝光平光镜
- 型号 ZY-18322
- 镜片类型 防蓝光、抗辐射
- 使用人群 男女同款
- 产品重量 11g
- 框型材质 不锈钢材质
- 眼镜框型 方形

## 产品尺寸



注: 以上尺寸均为手工测量, 测量的方法不同可能存在1-3mm偏差, 收到请以实物为准。

## 颜色展示



黑色



浅枪色



黑银色



黑金色



金色



玫瑰金

## Product Parameters

## 产品参数

产品型号: ZY8021

产品功能: 防蓝光、装饰

眼镜重量: 14.8g (不含镜片)

适合脸型: 通用脸型

镜框材质: 金属

适合性别: 男女



镜总宽

140mm

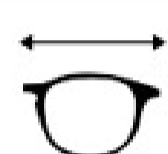

镜片宽

51mm



镜片高

32mm



鼻间距

19mm



镜腿长

145mm

注: 以上尺寸均为手工测量, 存在一定的误差, 敬请谅解!

## COLOR DISPLAY

### 颜色展示



の 金框



の 银框



の 黑框

# PRODUCT INFO

## 产品信息



\*以上参数属于手工测量。允许存在一定合理范围内误差，具体以实物为准

型号：ZY-20233

材质：铝镁+钛

重量：11g(不含镜片)

性别：男女通用

风格：时尚

功能：配镜

## 可选颜色

OPTIONAL COLOR



黑框



黑枪框



黑金框



黑银框

# INFORMATION

## 参数信息



眼镜型号：ZY-20250

眼镜风格：商务

镜框材质：铝镁+钛

镜片功能：可配镜

适用性别：中性款

镜框重量：约11.3g(不含镜片)

注：以上镜框尺寸数据均为手工测量，可能存在1~3mm误差，请以实物为准。

## 可选颜色



砂黑框



砂黑银框



砂黑枪框



砂黑金框



砂灰银框

# INFORMATION

## 参数信息



眼镜型号：ZY-20248

眼镜风格：商务

镜框材质：铝镁+钛

镜片功能：可配镜

适用性别：中性款

镜框重量：约11g(不含镜片)

注：以上镜框尺寸数据均为手工测量，可能存在1~3mm误差，请以实物为准。

## 可选颜色



砂黑金框



砂灰银框



砂黑枪框



砂黑银框



砂黑框

# INFORMATION

## 参数信息



眼镜型号：ZY-20245

眼镜风格：商务

镜框材质：铝镁+钛

镜片功能：可配镜

适用性别：中性款

镜框重量：约11g(不含镜片)

注：以上镜框尺寸数据均为手工测量，可能存在1~3mm误差，请以实物为准。

## 可选颜色



砂黑金框



砂灰银框



砂黑枪框



砂黑银框



砂黑框

# INFORMATION

## 参数信息



眼镜型号：ZY-20239

眼镜风格：商务

镜框材质：铝镁+钛

镜片功能：可配镜

适用性别：中性款

镜框重量：约12g(不含镜片)

注：以上镜框尺寸数据均为手工测量，可能存在1~3mm误差，请以实物为准。

## 可选颜色



砂黑框



砂黑银框



砂黑枪框



砂黑金框



砂灰银框

# INFORMATION

## 参数信息



眼镜型号：ZY-20229

眼镜风格：休闲

镜框材质：铝镁+钛

镜片功能：可配镜

适用性别：中性款

镜框重量：约10.5g(不含镜片)

注：以上镜框尺寸数据均为手工测量，可能存在1~3mm误差，请以实物为准。

## 可选颜色



黑金框



黑色框



银色框



黑枪框



黑银框

# INFORMATION

## 参数信息



眼镜型号：ZY-20241

眼镜风格：商务

镜框材质：铝镁+钛

镜片功能：可配镜

适用性别：中性款

镜框重量：约11.7g(不含镜片)

注：以上镜框尺寸数据均为手工测量，可能存在1~3mm误差，请以实物为准。

## 可选颜色



砂黑枪框



砂黑框



砂黑金框



砂黑银框



砂灰银框